



# Documentazione Tubo a raggi X

## Tube Documentation

### Documentation du Tube

# RTC 600 HS 0.6/1.5

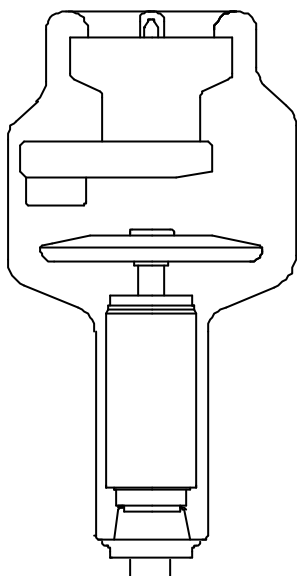

**Versione speciale per sostituzione in cuffie GE-CGR e SIEMENS**

Fornito con adattatore anodico

**Special version for reloading in GE-CGR and SIEMENS housings**

Supplied with anode end adaptation piece

**Version spéciale pour remise en gaine GE-CGR et SIEMENS**

Fourni avec adaptateur anodique

Nr. di matricola  
Tube No.  
Nr de série



Questa documentazione deve essere fornita all'utilizzatore del complesso tubo-guaina  
The contents of this documentation must be transmitted to the user of the tube-assembly  
Le contenu de cette documentation doit être transmis à l'utilisateur de la gaine équipée

Documentazione N° Documentation N° N° de Documentation	Revisione Edition Version	Data di edizione Date of release Date de l'édition	Testo originale Original text Texte original
600Z6F	0	16.05.2000	italiano / italian / italien



















**I.A.E Spa**

via Fabio Filzi, 53 - 20032 CORMANO (MI) Italy  
Tel: ++39-0266303255 Fax: ++39-026152544  
<http://www.iae.it> e-mail: [iaexray@iae.it](mailto:iaexray@iae.it)





**Sommario - Table of contents - Table des matières**

Sommario - Table of contents - Table des matières.....	2
Caratteristiche - Specifications - Spécifications .....	3
Dimensioni - Dimension - Dimensions .....	3
Curve di riscaldamento e raffreddamento dell'anodo Anode heating and cooling curves Courbes d'échauffement et de refroidissement de l'anode.....	4
CURVE DI CARICO SINGOLO - SINGLE LOAD RATING - ABAQUE DE CHARGE UNIQUE  0.6 - 1 ~ - 3000 min <sup>-1</sup> .....	5
CURVE DI CARICO SINGOLO - SINGLE LOAD RATING - ABAQUE DE CHARGE UNIQUE  1.5 - 1 ~ - 3000 min <sup>-1</sup> .....	5
CURVE DI CARICO SINGOLO - SINGLE LOAD RATING - ABAQUE DE CHARGE UNIQUE  0.6 - 3 ~ - 3000 min <sup>-1</sup> .....	6
CURVE DI CARICO SINGOLO - SINGLE LOAD RATING - ABAQUE DE CHARGE UNIQUE  1.5 - 3 ~ - 3000 min <sup>-1</sup> .....	6
CURVE DI CARICO SINGOLO - SINGLE LOAD RATING - ABAQUE DE CHARGE UNIQUE  0.6 - 1 ~ - 10000 min <sup>-1</sup> .....	7
CURVE DI CARICO SINGOLO - SINGLE LOAD RATING - ABAQUE DE CHARGE UNIQUE  1.5 - 1 ~ - 10000 min <sup>-1</sup> .....	7
CURVE DI CARICO SINGOLO - SINGLE LOAD RATING - ABAQUE DE CHARGE UNIQUE  0.6 - 3 ~ - 10000 min <sup>-1</sup> .....	8
CURVE DI CARICO SINGOLO - SINGLE LOAD RATING - ABAQUE DE CHARGE UNIQUE  1.5 - 3 ~ - 10000 min <sup>-1</sup> .....	8
Abaco per carichi in serie - Serial load rating - Abaque de charges successives  0.6 - 1 ~ - 3000 min <sup>-1</sup> .....	9
Abaco per carichi in serie - Serial load rating - Abaque de charges successives  1.5 - 1 ~ - 3000 min <sup>-1</sup> .....	10
Abaco per carichi in serie - Serial load rating - Abaque de charges successives  0.6 - 3 ~ - 3000 min <sup>-1</sup> .....	11
Abaco per carichi in serie - Serial load rating - Abaque de charges successives  1.5 - 3 ~ - 3000 min <sup>-1</sup> .....	12
Abaco per carichi in serie - Serial load rating - Abaque de charges successives  0.6 - 1 ~ - 10000 min <sup>-1</sup> .....	13
Abaco per carichi in serie - Serial load rating - Abaque de charges successives  1.5 - 1 ~ - 10000 min <sup>-1</sup> .....	14
Abaco per carichi in serie - Serial load rating - Abaque de charges successives  0.6 - 3 ~ - 10000 min <sup>-1</sup> .....	15
Abaco per carichi in serie - Serial load rating - Abaque de charges successives  1.5 - 3 ~ - 10000 min <sup>-1</sup> .....	16
Caratteristica di emissione del catodo Cathode emission characteristic Caractéristique d'émission de la cathode  0.6 - 3 ~ - (± 0.2 A).....	17
Caratteristica di emissione del catodo Cathode emission characteristic Caractéristique d'émission de la cathode  1.5 - 3 ~ - (± 0.2 A).....	17

**Dichiarazione di conformità**

Questo prodotto soddisfa i requisiti essenziali della direttiva 93/42/CEE in  
accordo alle norme EN 60613 (IEC 613) e EN 60336 (IEC 336)

**Declaration of conformity**





This tube fulfils the essential requirements of the directive 93/42/EEC  
according to standard EN 60613 (IEC 613) and EN 60336 (IEC 336).

**Confirmation de conformité**

Ce tube remplit les exigences essentielles de la directive 93/42/CEE en  
accord avec les normes EN 60613 (IEC 613) et EN 60336 (IEC 336).



**Caratteristiche - Specifications - Spécifications**

Macchie focali Focal spot Foyer	 0.6  1.5	(IEC 336, EN 60336)
Velocità di rotazione dell'anodo Anode speed Vitesse de l'anode	3000 min <sup>-1</sup> 10000 min <sup>-1</sup>	
Potenza anodica nominale Nominal anode input power Puissance anodique nominale	 24 kW 43 kW  70 kW 125 kW	(IEC 613, EN 60613)
Diametro anodico Anode diameter Diamètre de l'anode	102 mm	
Materiale anodico Anode material Matériau de l'anode	RT-TZM-C	
Angolo anodico Anode angle Pente de l'anode	13 °	
Campo di radiazione Radiation field Champ de rayonnement	a 70 cm 32 cm a 100 cm 45 cm	
Filtrazione inerente Inherent filtration Filtration inhérente	0.7 mm Al eq	(IEC 522)
Capacità termica anodica Maximum anode heat content Chaleur maximale accumulée dans l'anode	450 kJ 600 kHU	
Dissipazione termica continua Continuous heat dissipation Dissipation thermique continue	1000 W 80 000 HU/min	
Dissipazione termica massima Maximum heat dissipation Dissipation thermique maximale	1500 W 125 000 HU/min	
Alta tensione nominale Nominal X-ray tube voltage Haute tension nominale	150 kV	
Massima corrente di filamento Max. filament current Courant dans le filament max.	5.4 A	

I dati forniti nella presente documentazione si intendono riferiti a:

The data indicated in this documentation refer to:

Les données indiquées dans cette documentation sont calculées pour:

Potenza anodica di equilibrio termico		% della capacità termica anodica	
Equivalent anode input power	175 W =	% of maximum anode heat content	42%
Puissance anodique d'équilibre thermique		% de chaleur max. accumulée dans l'anode	

**Dimensioni - Dimension - Dimensions**

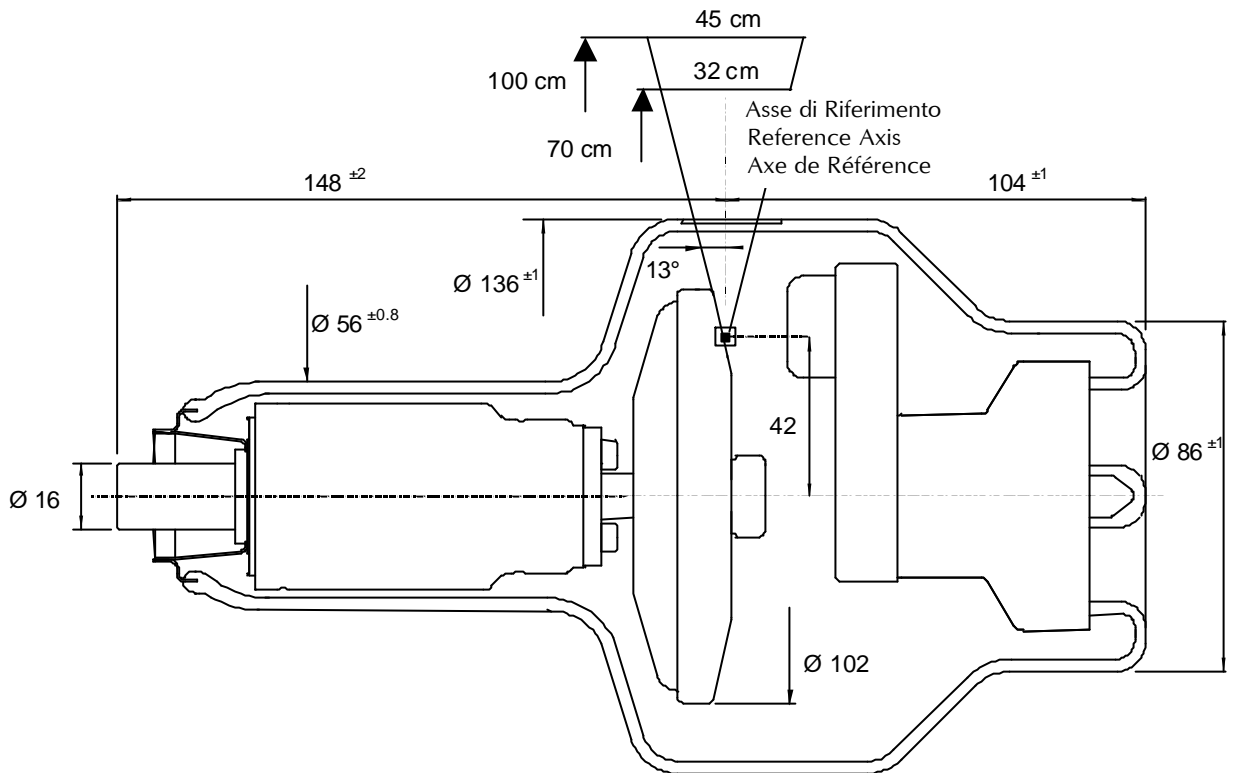

**Curve di riscaldamento e raffreddamento dell'anodo**  
**Anode heating and cooling curves**  
**Courbes d'échauffement et de refroidissement de l'anode**

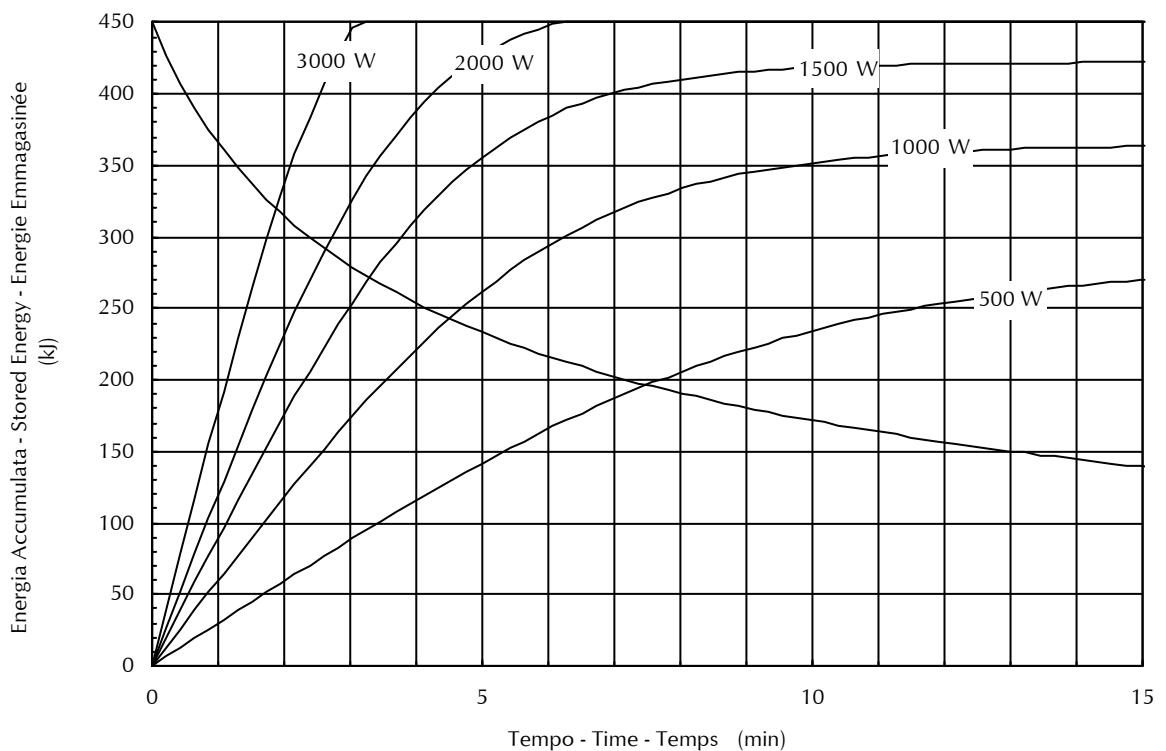



**CURVE DI CARICO SINGOLO - SINGLE LOAD RATING - ABAQUE DE CHARGE UNIQUE**

▣ 0.6 - 1 ~ - 3000 min<sup>-1</sup>

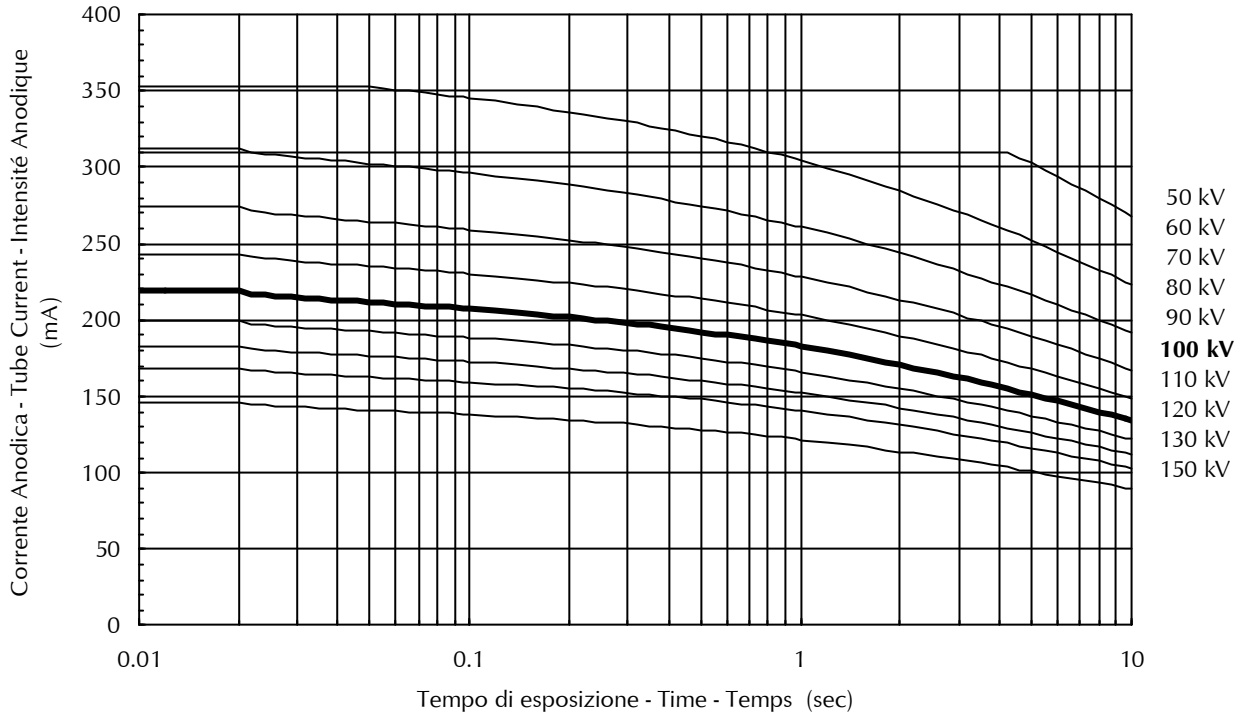

**CURVE DI CARICO SINGOLO - SINGLE LOAD RATING - ABAQUE DE CHARGE UNIQUE**

■ 1.5 - 1 ~ - 3000 min<sup>-1</sup>

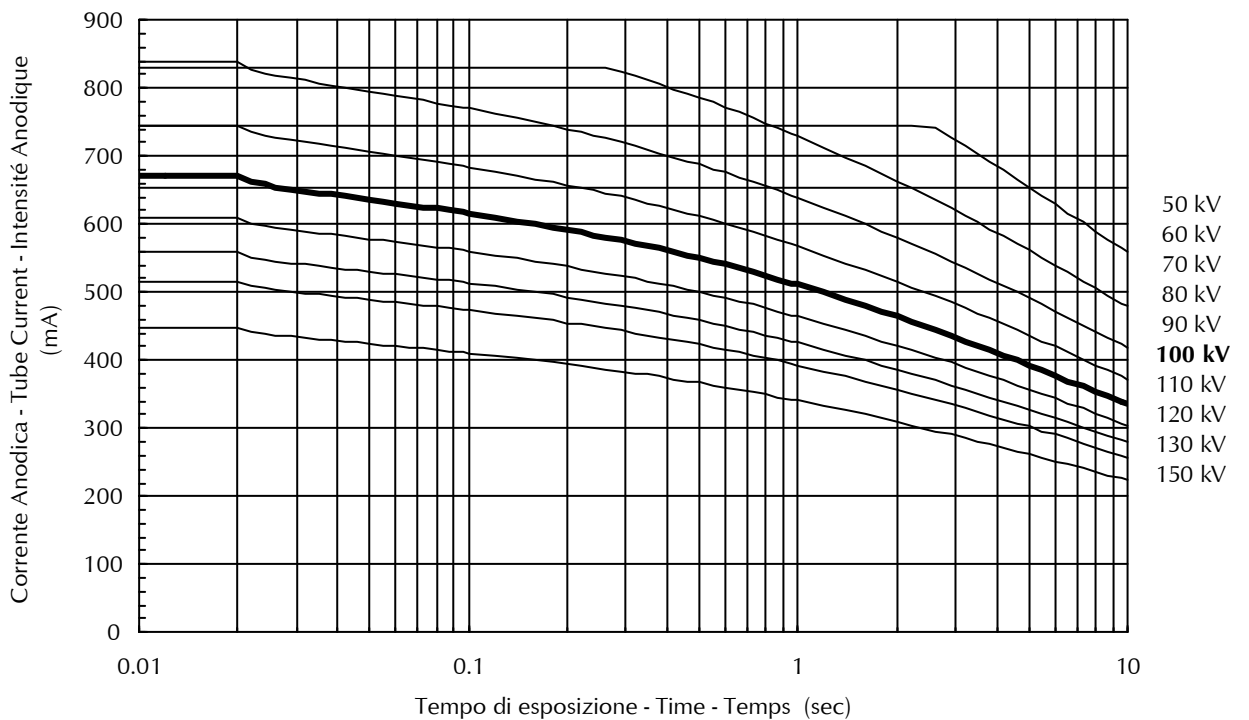



**CURVE DI CARICO SINGOLO - SINGLE LOAD RATING - ABAQUE DE CHARGE UNIQUE**

▣ 0.6 - 3 ~ - 3000 min<sup>-1</sup>

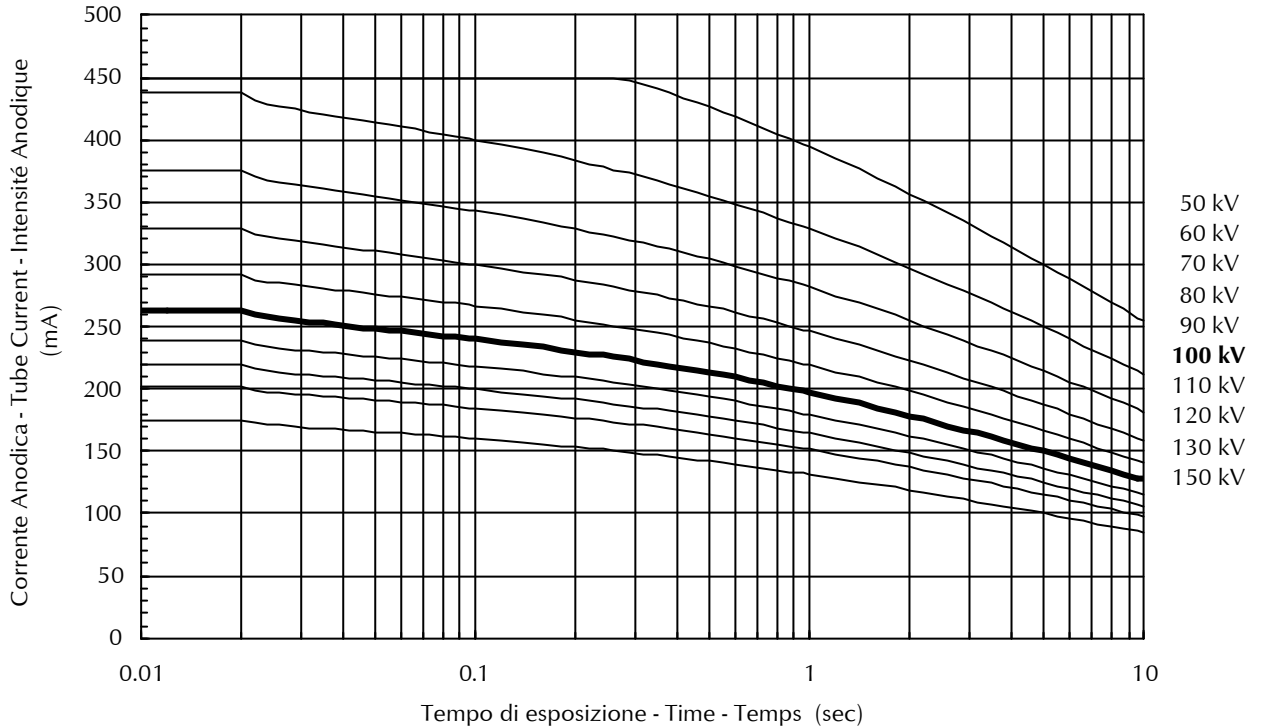

**CURVE DI CARICO SINGOLO - SINGLE LOAD RATING - ABAQUE DE CHARGE UNIQUE**

■ 1.5 - 3 ~ - 3000 min<sup>-1</sup>

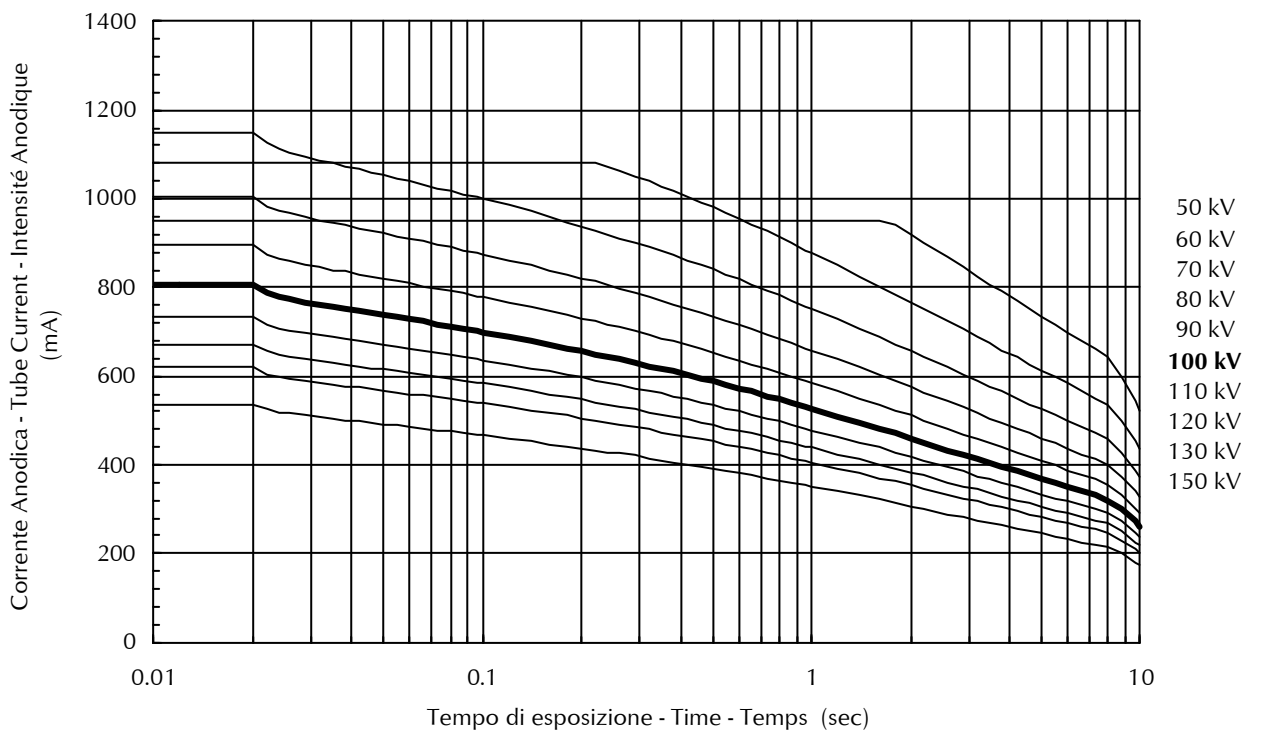



**CURVE DI CARICO SINGOLO - SINGLE LOAD RATING - ABAQUE DE CHARGE UNIQUE**

▣ 0.6 - 1 ~ - 10000 min<sup>-1</sup>

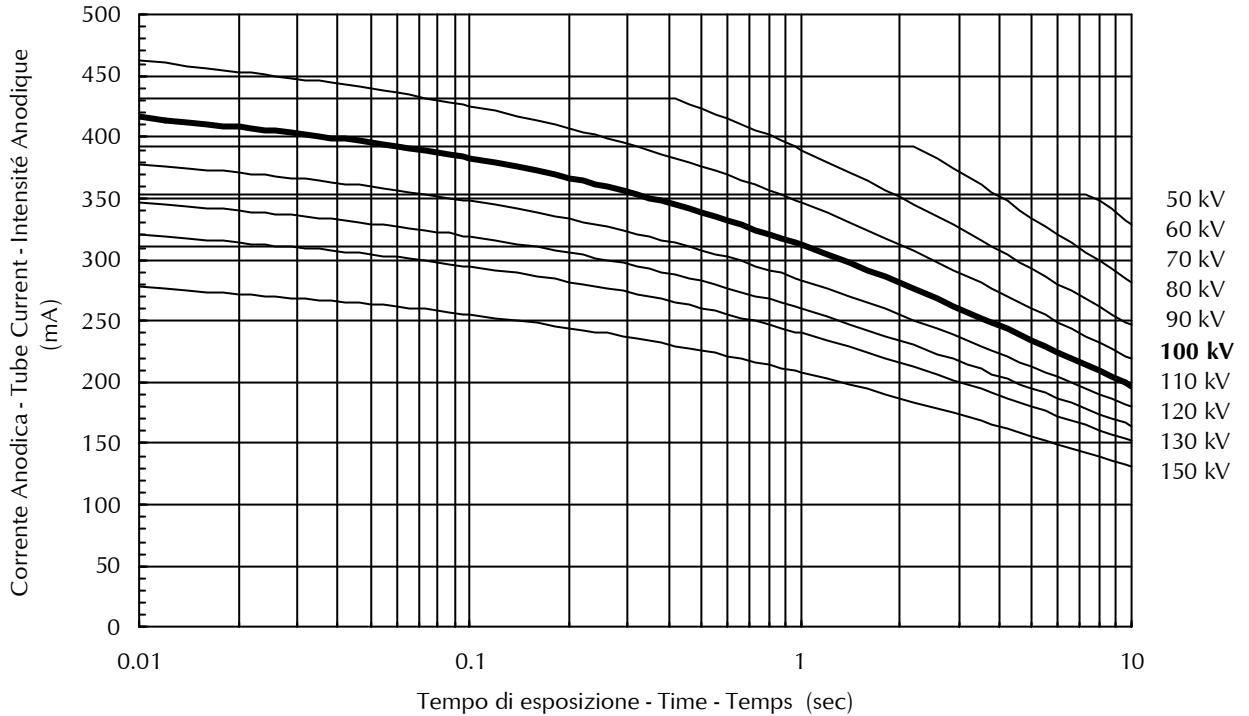

**CURVE DI CARICO SINGOLO - SINGLE LOAD RATING - ABAQUE DE CHARGE UNIQUE**

■ 1.5 - 1 ~ - 10000 min<sup>-1</sup>

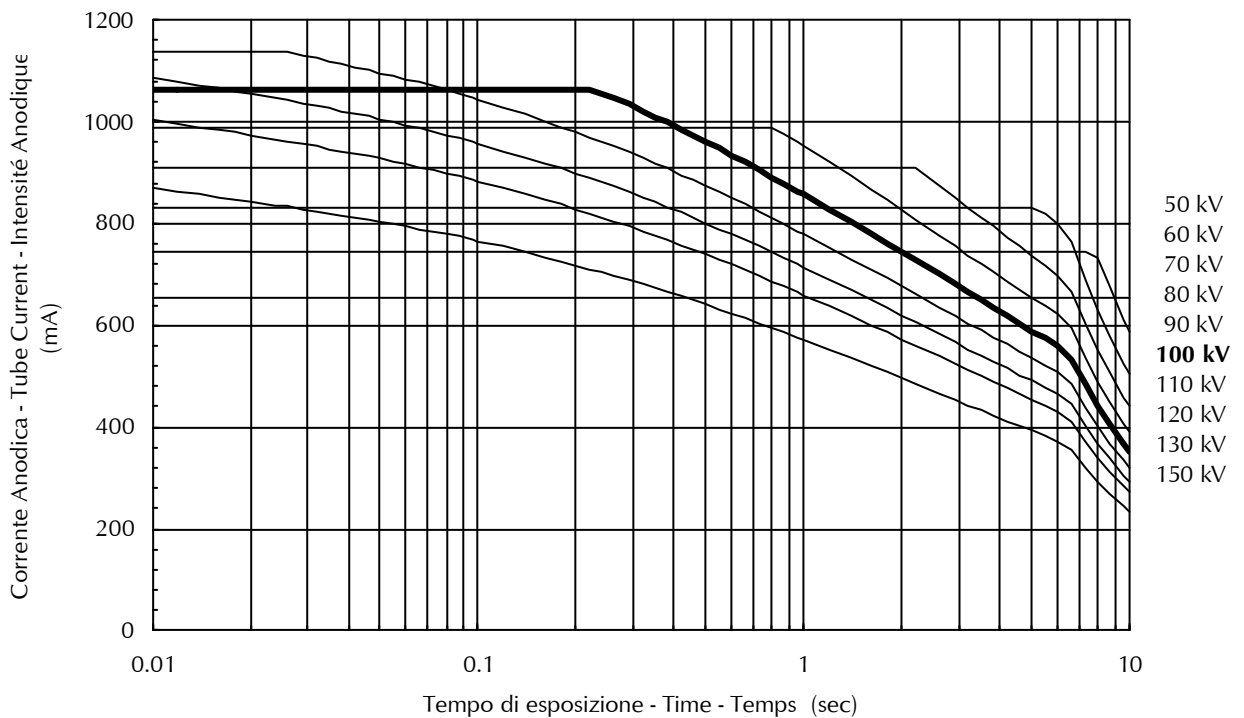



**CURVE DI CARICO SINGOLO - SINGLE LOAD RATING - ABAQUE DE CHARGE UNIQUE**

▣ 0.6 - 3 ~ - 10000 min<sup>-1</sup>

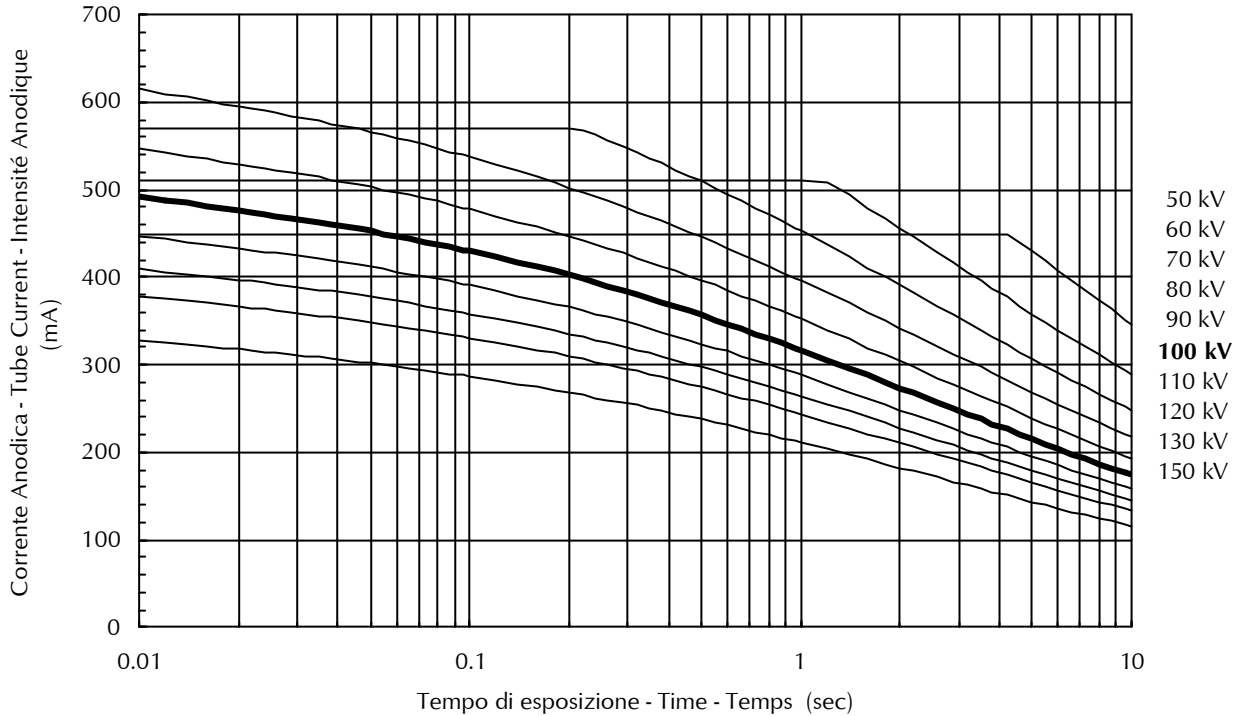

**CURVE DI CARICO SINGOLO - SINGLE LOAD RATING - ABAQUE DE CHARGE UNIQUE**

■ 1.5 - 3 ~ - 10000 min<sup>-1</sup>

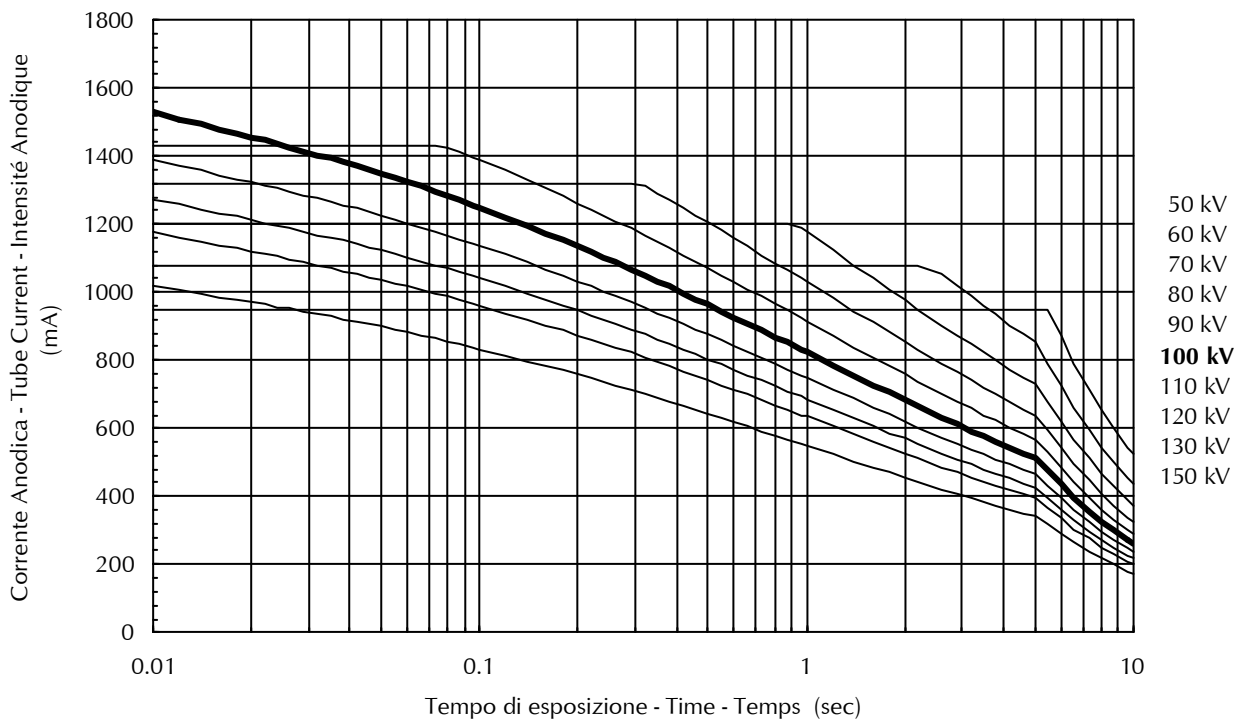





**Abaco per carichi in serie - Serial load rating - Abaque de charges successives**

▣ **0.6 - 1 ~ - 3000 min<sup>-1</sup>**

Potenza ammessa sul tubo in kW, per serie di n esposizioni, con frequenza z e durata di ogni esposizione in sec Anode input power as a function of n (N° of exposures in series), z (exp. rate per sec), the exposure time (sec) Puissance anodique en fonction de n (N° d'exp. de la séries), z (cadence d'exp. par sec), temps d'exposition (sec)																
z	0.010	0.020	0.030	0.040	0.050	0.060	0.080	0.100	0.120	0.140	0.160	0.180	0.200	0.220	0.250	n
1	17.3	17.3	17.0	16.9	16.7	16.6	16.4	16.2	16.1	16.0	15.9	15.7	15.6	15.4	15.2	5
2	17.2	17.2	17.0	16.9	16.7	16.6	16.4	16.1	15.8	15.6	15.4	15.1	14.9	14.7	14.4	
3	17.2	17.2	17.0	16.8	16.6	16.5	16.1	15.8	15.5	15.2	14.9	14.7	14.4	14.2	13.8	
4	17.1	17.1	16.9	16.7	16.5	16.3	15.9	15.6	15.2	14.9	14.6	14.3	14.0	13.8	13.4	
5	17.1	17.1	16.8	16.6	16.4	16.2	15.8	15.4	15.0	14.7	14.3	14.0	13.7	-	-	
10	17.0	16.9	16.6	16.3	16.0	15.7	15.2	14.7	-	-	-	-	-	-	-	
15	17.0	16.7	16.4	16.0	15.7	15.4	-	-	-	-	-	-	-	-	-	
30	17.0	16.5	16.0	-	-	-	-	-	-	-	-	-	-	-	-	
1	17.2	17.2	17.0	16.9	16.7	16.6	16.4	16.1	15.8	15.6	15.3	15.1	14.9	14.7	14.3	10
2	17.1	17.1	16.9	16.7	16.5	16.3	15.9	15.6	15.2	14.9	14.6	14.3	14.0	13.7	13.3	
3	17.0	17.0	16.8	16.5	16.3	16.0	15.6	15.2	14.8	14.4	14.1	13.7	13.4	13.1	12.7	
4	17.0	16.9	16.6	16.4	16.1	15.8	15.4	14.9	14.5	14.0	13.7	13.3	12.9	12.6	12.1	
5	17.0	16.9	16.5	16.2	15.9	15.7	15.1	14.6	14.2	13.7	13.3	12.9	12.6	-	-	
10	17.0	16.6	16.2	15.8	15.4	15.0	14.3	13.7	-	-	-	-	-	-	-	
15	17.0	16.4	15.9	15.4	15.0	14.6	-	-	-	-	-	-	-	-	-	
30	16.7	16.0	15.4	-	-	-	-	-	-	-	-	-	-	-	-	
1	17.1	17.1	16.9	16.7	16.5	16.3	15.9	15.6	15.2	14.9	14.6	14.3	14.0	13.7	13.3	20
2	17.0	16.9	16.6	16.4	16.1	15.8	15.3	14.9	14.4	14.0	13.6	13.3	12.9	12.6	12.1	
3	17.0	16.8	16.5	16.1	15.8	15.5	14.9	14.4	13.9	13.4	13.0	12.6	12.2	11.9	11.4	
4	17.0	16.7	16.3	15.9	15.6	15.2	14.6	14.0	13.5	13.0	12.5	12.1	11.7	11.3	10.8	
5	17.0	16.6	16.2	15.8	15.4	15.0	14.3	13.7	13.1	12.6	12.1	11.6	11.2	-	-	
10	16.9	16.2	15.7	15.1	14.6	14.2	13.3	12.6	-	-	-	-	-	-	-	
15	16.7	16.0	15.3	14.7	14.1	13.6	-	-	-	-	-	-	-	-	-	
30	16.4	15.4	14.6	-	-	-	-	-	-	-	-	-	-	-	-	
1	17.0	16.9	16.6	16.4	16.1	15.8	15.3	14.9	14.4	14.0	13.6	13.3	12.9	12.6	12.1	40
2	17.0	16.7	16.3	15.9	15.6	15.2	14.6	14.0	13.5	13.0	12.5	12.1	11.7	11.3	10.8	
3	17.0	16.5	16.0	15.6	15.2	14.8	14.1	13.4	12.8	12.3	11.7	11.3	10.9	10.5	9.9	
4	16.9	16.4	15.8	15.3	14.9	14.4	13.6	12.9	12.3	11.7	11.2	10.7	10.2	9.8	9.3	
5	16.9	16.2	15.7	15.1	14.6	14.2	13.3	12.5	11.9	11.3	10.7	10.2	9.8	-	-	
10	16.6	15.8	15.0	14.3	13.7	13.1	12.1	11.2	-	-	-	-	-	-	-	
15	16.4	15.4	14.5	13.8	13.1	12.4	-	-	-	-	-	-	-	-	-	
30	16.0	14.7	13.6	-	-	-	-	-	-	-	-	-	-	-	-	
1	17.0	16.8	16.5	16.1	15.8	15.5	14.9	14.4	13.9	13.4	13.0	12.6	12.2	11.9	11.4	60
2	17.0	16.5	16.0	15.6	15.2	14.8	14.1	13.4	12.8	12.2	11.7	11.3	10.8	10.5	9.9	
3	16.9	16.3	15.7	15.2	14.7	14.3	13.5	12.7	12.1	11.5	10.9	10.4	10.0	9.6	9.0	
4	16.8	16.1	15.5	14.9	14.4	13.9	13.0	12.2	11.5	10.9	10.3	9.8	9.4	9.0	8.4	
5	16.7	16.0	15.3	14.7	14.1	13.6	12.6	11.8	11.1	10.4	9.9	9.3	8.9	-	-	
10	16.4	15.4	14.5	13.7	13.0	12.4	11.3	10.4	-	-	-	-	-	-	-	
15	16.2	15.0	14.0	13.1	12.3	11.6	-	-	-	-	-	-	-	-	-	
30	15.7	14.2	12.9	-	-	-	-	-	-	-	-	-	-	-	-	
1	17.0	16.7	16.3	15.9	15.6	15.2	14.6	14.0	13.5	13.0	12.5	12.1	11.7	11.3	10.8	80
2	16.9	16.4	15.8	15.3	14.9	14.4	13.6	12.9	12.3	11.7	11.2	10.7	10.2	9.8	9.3	
3	16.8	16.1	15.5	14.9	14.4	13.9	13.0	12.2	11.5	10.9	10.3	9.8	9.4	9.0	8.4	
4	16.7	15.9	15.2	14.6	14.0	13.5	12.5	11.7	10.9	10.3	9.7	9.2	8.7	8.3	7.8	
5	16.6	15.8	15.0	14.3	13.7	13.1	12.1	11.2	10.5	9.8	9.2	8.7	8.3	-	-	
10	16.2	15.1	14.2	13.3	12.5	11.9	10.7	9.8	-	-	-	-	-	-	-	
15	16.0	14.7	13.6	12.6	11.8	11.1	-	-	-	-	-	-	-	-	-	
30	15.4	13.8	12.4	-	-	-	-	-	-	-	-	-	-	-	-	
1	17.0	16.6	16.2	15.8	15.4	15.0	14.3	13.7	13.1	12.6	12.1	11.6	11.2	10.8	10.3	100
2	16.9	16.2	15.7	15.1	14.6	14.2	13.3	12.5	11.9	11.3	10.7	10.2	9.8	9.4	8.8	
3	16.7	16.0	15.3	14.7	14.1	13.6	12.6	11.8	11.1	10.4	9.9	9.3	8.9	8.5	7.9	
4	16.6	15.8	15.0	14.3	13.7	13.1	12.1	11.2	10.5	9.8	9.2	8.7	8.3	7.8	7.3	
5	16.5	15.6	14.7	14.0	13.3	12.7	11.7	10.8	10.0	9.3	8.7	8.2	7.8	-	-	
10	16.1	14.9	13.8	12.9	12.1	11.4	10.2	9.3	-	-	-	-	-	-	-	
15	15.8	14.4	13.2	12.2	11.4	10.6	-	-	-	-	-	-	-	-	-	
30	15.2	13.4	12.0	-	-	-	-	-	-	-	-	-	-	-	-	
1	16.9	16.4	15.9	15.4	15.0	14.5	13.7	13.0	12.4	11.8	11.3	10.8	10.1	9.1	8.0	150
2	16.7	16.0	15.3	14.7	14.1	13.6	12.6	11.8	11.1	10.4	9.9	9.3	8.5	7.7	6.8	
3	16.5	15.7	14.9	14.2	13.5	12.9	11.9	11.0	10.2	9.6	9.0	8.5	8.0	7.3	6.4	
4	16.4	15.4	14.5	13.7	13.0	12.4	11.3	10.4	9.6	8.9	8.3	7.8	7.4	7.0	6.2	
5	16.3	15.2	14.2	13.4	12.7	12.0	10.8	9.9	9.1	8.4	7.9	7.3	6.9	-	-	
10	15.8	14.4	13.2	12.2	11.4	10.6	9.4	8.4	-	-	-	-	-	-	-	
15	15.5	13.8	12.5	11.4	10.5	9.7	-	-	-	-	-	-	-	-	-	
30	14.8	12.7	11.2	-	-	-	-	-	-	-	-	-	-	-	-	
1	16.7	16.0	15.3	14.7	14.1	13.6	12.6	11.8	11.0	10.4	9.4	8.2	7.3	6.6	5.3	300
2	16.4	15.4	14.5	13.7	13.0	12.4	11.3	10.1	8.4	7.2	6.3	5.6	5.0	4.6	4.0	
3	16.2	15.0	14.0	13.1	12.3	11.6	10.5	9.0	7.5	6.4	5.6	5.0	4.5	4.1	3.6	
4	16.0	14.7	13.6	12.6	11.8	11.1	9.9	8.5	7.1	6.1	5.3	4.7	4.3	3.9	3.4	
5	15.8	14.4	13.2	12.2	11.4	10.6	9.4	8.2	6.8	5.9	5.1	4.6	4.1	-	-	
10	15.2	13.4	12.0	10.8	9.9	9.1	7.9	6.9	-	-	-	-	-	-	-	
15	14.7	12.7	11.2	10.0	9.0	8.2	-	-	-	-	-	-	-	-	-	
30	13.8	11.4	9.7	-	-	-	-	-	-	-	-	-	-	-	-	



**Abaco per carichi in serie - Serial load rating - Abaque de charges successives**

■ 1.5 - 1 ~ - 3000 min<sup>-1</sup>

Potenza ammessa sul tubo in kW, per serie di n esposizioni, con frequenza z e durata di ogni esposizione in sec																
Anode input power as a function of n (N° of exposures in series), z (exp. rate per sec), the exposure time (sec)																
Puissance anodique en fonction de n (N° d'exp. de la série), z (cadence d'exp. par sec), temps d'exposition (sec)																
z	0.010	0.020	0.030	0.040	0.050	0.060	0.080	0.100	0.120	0.140	0.160	0.180	0.200	0.220	0.250	n
1	52.7	52.7	51.4	50.5	49.9	49.3	48.4	47.7	47.1	46.5	46.0	45.6	44.8	44.1	43.0	5
2	52.2	52.2	51.4	50.5	49.9	49.3	48.3	47.1	46.0	44.9	43.9	42.9	42.0	41.1	39.8	
3	51.9	51.9	51.1	50.3	49.5	48.7	47.2	45.9	44.6	43.3	42.2	41.1	40.0	39.0	37.6	
4	51.7	51.7	50.7	49.8	48.9	48.0	46.4	44.9	43.4	42.1	40.8	39.6	38.5	37.5	36.0	
5	51.4	51.4	50.4	49.4	48.4	47.4	45.7	44.0	42.5	41.1	39.7	38.5	37.3	-	-	
10	51.4	50.6	49.2	47.8	46.5	45.3	43.1	41.1	-	-	-	-	-	-	-	
15	51.4	50.0	48.3	46.7	45.3	43.9	-	-	-	-	-	-	-	-	-	
30	51.1	48.7	46.6	-	-	-	-	-	-	-	-	-	-	-	-	
1	52.2	52.2	51.4	50.5	49.9	49.3	48.3	47.1	46.0	44.9	43.9	42.9	41.9	41.0	39.8	10
2	51.7	51.7	50.7	49.8	48.9	48.0	46.4	44.8	43.4	42.0	40.8	39.6	38.5	37.4	35.9	
3	51.4	51.2	50.1	49.0	47.9	46.9	45.0	43.2	41.6	40.1	38.7	37.4	36.2	35.0	33.4	
4	51.4	50.9	49.5	48.3	47.1	46.0	43.9	42.0	40.2	38.6	37.1	35.7	34.4	33.2	31.6	
5	51.4	50.5	49.1	47.7	46.4	45.2	43.0	40.9	39.1	37.4	35.8	34.4	33.0	-	-	
10	51.4	49.4	47.4	45.7	44.0	42.5	39.7	37.3	-	-	-	-	-	-	-	
15	51.0	48.5	46.3	44.2	42.4	40.6	-	-	-	-	-	-	-	-	-	
30	50.0	46.7	43.9	-	-	-	-	-	-	-	-	-	-	-	-	
1	51.7	51.7	50.7	49.8	48.9	48.0	46.3	44.8	43.4	42.0	40.8	39.6	38.4	37.4	35.9	20
2	51.4	50.8	49.5	48.3	47.1	46.0	43.9	41.9	40.2	38.6	37.1	35.7	34.4	33.2	31.6	
3	51.4	50.3	48.7	47.2	45.8	44.5	42.1	40.0	38.0	36.3	34.7	33.2	31.8	30.6	28.9	
4	51.4	49.8	48.0	46.4	44.8	43.4	40.8	38.5	36.4	34.5	32.9	31.3	29.9	28.7	27.0	
5	51.4	49.3	47.4	45.6	44.0	42.4	39.6	37.2	35.1	33.1	31.4	29.9	28.5	-	-	
10	50.5	47.7	45.2	43.0	40.9	39.1	35.8	33.0	-	-	-	-	-	-	-	
15	49.9	46.6	43.7	41.1	38.9	36.8	-	-	-	-	-	-	-	-	-	
30	48.5	44.2	40.6	-	-	-	-	-	-	-	-	-	-	-	-	
1	51.4	50.8	49.5	48.3	47.1	46.0	43.8	41.9	40.2	38.5	36.5	32.5	29.2	26.6	23.4	40
2	51.4	49.8	48.0	46.3	44.8	43.4	40.8	38.4	36.4	34.5	32.8	30.7	27.7	25.2	22.1	
3	51.2	48.9	46.9	45.0	43.2	41.6	38.7	36.1	33.9	32.0	30.2	28.6	27.2	24.7	21.7	
4	50.8	48.3	46.0	43.9	41.9	40.2	37.1	34.4	32.1	30.1	28.3	26.7	25.3	24.0	21.5	
5	50.5	47.7	45.2	42.9	40.9	39.0	35.8	33.0	30.6	28.6	26.8	25.2	23.8	-	-	
10	49.3	45.6	42.4	39.6	37.2	35.1	31.4	28.5	-	-	-	-	-	-	-	
15	48.5	44.1	40.5	37.5	34.8	32.5	-	-	-	-	-	-	-	-	-	
30	46.6	41.1	36.8	-	-	-	-	-	-	-	-	-	-	-	-	
1	51.4	50.2	48.7	47.2	45.8	44.5	42.1	40.0	34.2	29.3	25.6	22.8	20.5	18.6	16.4	60
2	51.2	48.9	46.9	45.0	43.2	41.6	38.7	36.1	31.6	27.1	23.7	21.1	19.0	17.2	15.2	
3	50.7	48.0	45.6	43.4	41.4	39.6	36.4	33.7	30.7	26.4	23.1	20.5	18.4	16.8	14.8	
4	50.2	47.2	44.5	42.1	40.0	38.0	34.6	31.8	29.4	26.0	22.7	20.2	18.2	16.5	14.6	
5	49.9	46.5	43.6	41.1	38.8	36.8	33.3	30.4	27.9	25.8	22.5	20.0	18.0	-	-	
10	48.4	44.1	40.5	37.4	34.8	32.5	28.7	25.7	-	-	-	-	-	-	-	
15	47.4	42.4	38.4	35.1	32.3	29.9	-	-	-	-	-	-	-	-	-	
30	45.2	39.1	34.4	-	-	-	-	-	-	-	-	-	-	-	-	
1	51.4	49.8	48.0	46.3	44.8	43.4	40.4	32.3	26.9	23.1	20.2	17.9	16.2	14.7	12.9	80
2	50.8	48.3	46.0	43.8	41.9	40.2	36.5	29.2	24.3	20.9	18.3	16.2	14.6	13.3	11.7	
3	50.2	47.2	44.5	42.1	40.0	38.0	34.6	28.2	23.5	20.1	17.6	15.7	14.1	12.8	11.3	
4	49.8	46.3	43.4	40.8	38.4	36.4	32.8	27.7	23.1	19.8	17.3	15.4	13.8	12.6	11.1	
5	49.3	45.6	42.4	39.6	37.2	35.0	31.4	27.4	22.8	19.5	17.1	15.2	13.7	-	-	
10	47.7	42.9	39.0	35.8	33.0	30.6	26.8	23.8	-	-	-	-	-	-	-	
15	46.6	41.1	36.8	33.3	30.4	27.9	-	-	-	-	-	-	-	-	-	
30	44.1	37.5	32.5	-	-	-	-	-	-	-	-	-	-	-	-	
1	51.4	49.3	47.4	45.6	43.9	42.4	33.9	27.1	22.6	19.3	16.9	15.0	13.5	12.3	10.8	100
2	50.5	47.7	45.2	42.9	40.9	39.0	30.0	24.0	20.0	17.1	15.0	13.3	12.0	10.9	9.6	
3	49.9	46.5	43.6	41.1	38.8	36.7	28.7	23.0	19.1	16.4	14.4	12.8	11.5	10.4	9.2	
4	49.3	45.6	42.4	39.6	37.2	35.0	28.1	22.4	18.7	16.0	14.0	12.5	11.2	10.2	9.0	
5	48.9	44.8	41.4	38.4	35.9	33.7	27.7	22.1	18.4	15.8	13.8	12.3	11.1	-	-	
10	47.1	41.9	37.8	34.4	31.6	29.2	25.3	21.5	-	-	-	-	-	-	-	
15	45.8	40.0	35.4	31.8	28.9	26.4	-	-	-	-	-	-	-	-	-	
30	43.2	36.2	31.1	-	-	-	-	-	-	-	-	-	-	-	-	
1	50.9	48.4	46.2	44.1	40.2	33.5	25.1	20.1	16.8	14.4	12.6	11.2	10.1	9.1	8.0	150
2	49.9	46.5	43.6	41.1	34.1	28.4	21.3	17.0	14.2	12.2	10.6	9.5	8.5	7.7	6.8	
3	49.1	45.2	41.9	39.0	32.0	26.7	20.0	16.0	13.3	11.4	10.0	8.9	8.0	7.3	6.4	
4	48.4	44.1	40.5	37.4	31.0	25.8	19.3	15.5	12.9	11.1	9.7	8.6	7.7	7.0	6.2	
5	47.9	43.2	39.3	36.1	30.3	25.3	19.0	15.2	12.6	10.8	9.5	8.4	7.6	-	-	
10	45.8	40.0	35.4	31.8	28.9	24.3	18.2	14.6	-	-	-	-	-	-	-	
15	44.4	37.8	32.9	29.2	26.2	23.7	-	-	-	-	-	-	-	-	-	
30	41.4	33.7	28.4	-	-	-	-	-	-	-	-	-	-	-	-	
1	49.9	46.5	43.6	32.9	26.3	21.9	16.4	13.2	11.0	9.4	8.2	7.3	6.6	6.0	5.3	300
2	48.4	44.1	33.5	25.1	20.1	16.8	12.6	10.1	8.4	7.2	6.3	5.6	5.0	4.6	4.0	
3	47.4	42.4	30.1	22.6	18.1	15.0	11.3	9.0	7.5	6.4	5.6	5.0	4.5	4.1	3.6	
4	46.5	41.1	28.4	21.3	17.0	14.2	10.6	8.5	7.1	6.1	5.3	4.7	4.3	3.9	3.4	
5	45.8	40.0	27.3	20.5	16.4	13.7	10.3	8.2	6.8	5.9	5.1	4.6	4.1	-	-	
10	43.2	36.1	25.3	19.0	15.2	12.6	9.5	7.6	-	-	-	-	-	-	-	
15	41.4	33.7	24.6	18.4	14.8	12.3	-	-	-	-	-	-	-	-	-	
30	37.8	29.2	23.7	-	-	-	-	-	-	-	-	-	-	-	-	



**Abaco per carichi in serie - Serial load rating - Abaque de charges successives**

▣ **0.6 - 3 ~ - 3000 min<sup>-1</sup>**

Potenza ammessa sul tubo in kW, per serie di n esposizioni, con frequenza z e durata di ogni esposizione in sec Anode input power as a function of n (N° of exposures in series), z (exp. rate per sec), the exposure time (sec) Puissance admissible en fonction de n (N° d'exp. de la série), z (cadence d'exp. par sec), temps d'exposition (sec)																
z	0.010	0.020	0.030	0.040	0.050	0.060	0.080	0.100	0.120	0.140	0.160	0.180	0.200	0.220	0.250	n
1	20.7	20.7	20.3	20.1	19.9	19.7	19.4	19.2	19.0	18.8	18.7	18.5	18.3	18.0	17.7	5
2	20.6	20.6	20.3	20.1	19.9	19.7	19.4	19.0	18.7	18.3	18.0	17.7	17.3	17.0	16.6	
3	20.5	20.5	20.2	20.0	19.7	19.5	19.1	18.6	18.2	17.8	17.4	17.0	16.7	16.4	15.9	
4	20.4	20.4	20.1	19.8	19.6	19.3	18.8	18.3	17.8	17.4	17.0	16.6	16.2	15.8	15.3	
5	20.4	20.4	20.0	19.7	19.4	19.1	18.6	18.0	17.5	17.0	16.6	16.2	15.8	-	-	
10	20.3	20.1	19.7	19.2	18.8	18.4	17.7	17.0	-	-	-	-	-	-	-	
15	20.3	19.9	19.4	18.9	18.4	18.0	-	-	-	-	-	-	-	-	-	
30	20.2	19.5	18.8	-	-	-	-	-	-	-	-	-	-	-	-	
1	20.6	20.6	20.3	20.1	19.9	19.7	19.4	19.0	18.6	18.3	18.0	17.6	17.3	17.0	16.6	10
2	20.4	20.4	20.1	19.8	19.6	19.3	18.8	18.3	17.8	17.4	16.9	16.5	16.2	15.8	15.3	
3	20.3	20.3	19.9	19.6	19.3	18.9	18.3	17.8	17.2	16.7	16.2	15.8	15.4	15.0	14.4	
4	20.3	20.2	19.8	19.4	19.0	18.7	18.0	17.3	16.8	16.2	15.7	15.2	14.8	14.3	13.7	
5	20.3	20.1	19.6	19.2	18.8	18.4	17.7	17.0	16.4	15.8	15.2	14.7	14.3	-	-	
10	20.3	19.7	19.1	18.6	18.0	17.5	16.6	15.8	-	-	-	-	-	-	-	
15	20.2	19.4	18.7	18.1	17.5	16.9	-	-	-	-	-	-	-	-	-	
30	19.9	18.9	18.0	-	-	-	-	-	-	-	-	-	-	-	-	
1	20.4	20.4	20.1	19.8	19.6	19.3	18.8	18.3	17.8	17.4	16.9	16.5	16.2	15.8	15.3	20
2	20.3	20.2	19.8	19.4	19.0	18.6	18.0	17.3	16.7	16.2	15.7	15.2	14.7	14.3	13.7	
3	20.3	20.0	19.5	19.0	18.6	18.2	17.4	16.7	16.0	15.4	14.8	14.3	13.8	13.4	12.7	
4	20.3	19.8	19.3	18.8	18.3	17.8	16.9	16.2	15.5	14.8	14.2	13.6	13.1	12.7	12.0	
5	20.3	19.7	19.1	18.5	18.0	17.5	16.6	15.7	15.0	14.3	13.7	13.1	12.6	-	-	
10	20.1	19.2	18.4	17.7	17.0	16.4	15.2	14.3	-	-	-	-	-	-	-	
15	19.9	18.8	17.9	17.1	16.3	15.6	-	-	-	-	-	-	-	-	-	
30	19.4	18.1	16.9	-	-	-	-	-	-	-	-	-	-	-	-	
1	20.3	20.2	19.8	19.4	19.0	18.6	18.0	17.3	16.7	16.2	15.7	15.2	14.7	14.3	13.7	40
2	20.3	19.8	19.3	18.8	18.3	17.8	16.9	16.2	15.4	14.8	14.2	13.6	13.1	12.6	12.0	
3	20.3	19.6	18.9	18.3	17.8	17.2	16.2	15.4	14.6	13.9	13.2	12.6	12.1	11.6	10.9	
4	20.2	19.4	18.6	18.0	17.3	16.7	15.7	14.7	13.9	13.2	12.5	11.9	11.4	10.9	10.2	
5	20.1	19.2	18.4	17.7	17.0	16.4	15.2	14.2	13.4	12.6	11.9	11.3	10.8	-	-	
10	19.7	18.5	17.5	16.6	15.7	15.0	13.7	12.6	-	-	-	-	-	-	-	
15	19.4	18.1	16.9	15.8	14.9	14.1	-	-	-	-	-	-	-	-	-	
30	18.8	17.1	15.6	-	-	-	-	-	-	-	-	-	-	-	-	
1	20.3	20.0	19.5	19.0	18.6	18.2	17.4	16.7	16.0	15.4	14.8	14.3	13.8	13.4	12.7	60
2	20.3	19.6	18.9	18.3	17.8	17.2	16.2	15.4	14.6	13.9	13.2	12.6	12.1	11.6	10.9	
3	20.1	19.3	18.5	17.8	17.2	16.5	15.4	14.5	13.6	12.9	12.2	11.6	11.0	10.5	9.9	
4	20.0	19.0	18.2	17.4	16.7	16.0	14.8	13.8	12.9	12.2	11.5	10.8	10.3	9.8	9.1	
5	19.9	18.8	17.9	17.1	16.3	15.6	14.3	13.3	12.4	11.6	10.9	10.3	9.7	-	-	
10	19.4	18.1	16.9	15.8	14.9	14.1	12.7	11.5	-	-	-	-	-	-	-	
15	19.1	17.5	16.1	15.0	14.0	13.1	-	-	-	-	-	-	-	-	-	
30	18.4	16.4	14.7	-	-	-	-	-	-	-	-	-	-	-	-	
1	20.3	19.8	19.3	18.8	18.3	17.8	16.9	16.2	15.4	14.8	14.2	13.6	13.1	12.6	12.0	80
2	20.2	19.4	18.6	18.0	17.3	16.7	15.7	14.7	13.9	13.2	12.5	11.9	11.4	10.9	10.2	
3	20.0	19.0	18.2	17.4	16.7	16.0	14.8	13.8	12.9	12.1	11.5	10.8	10.3	9.8	9.1	
4	19.8	18.8	17.8	16.9	16.2	15.4	14.2	13.1	12.2	11.4	10.7	10.1	9.5	9.0	8.4	
5	19.7	18.5	17.5	16.6	15.7	15.0	13.7	12.6	11.6	10.8	10.1	9.5	9.0	-	-	
10	19.2	17.7	16.4	15.2	14.2	13.4	11.9	10.8	-	-	-	-	-	-	-	
15	18.8	17.1	15.6	14.3	13.3	12.4	-	-	-	-	-	-	-	-	-	
30	18.1	15.8	14.1	-	-	-	-	-	-	-	-	-	-	-	-	
1	20.3	19.7	19.1	18.5	18.0	17.5	16.6	15.7	15.0	14.3	13.7	13.1	12.6	12.1	10.8	100
2	20.1	19.2	18.4	17.7	17.0	16.4	15.2	14.2	13.4	12.6	11.9	11.3	10.8	10.3	9.6	
3	19.9	18.8	17.9	17.0	16.3	15.6	14.3	13.3	12.4	11.6	10.9	10.3	9.7	9.2	8.6	
4	19.7	18.5	17.5	16.6	15.7	15.0	13.7	12.6	11.6	10.8	10.1	9.5	9.0	8.5	7.8	
5	19.6	18.3	17.2	16.2	15.3	14.5	13.1	12.0	11.0	10.2	9.5	8.9	8.4	-	-	
10	19.0	17.3	15.9	14.7	13.7	12.8	11.4	10.2	-	-	-	-	-	-	-	
15	18.6	16.7	15.1	13.8	12.7	11.8	-	-	-	-	-	-	-	-	-	
30	17.8	15.4	13.5	-	-	-	-	-	-	-	-	-	-	-	-	
1	20.2	19.4	18.7	18.0	17.4	16.9	15.8	14.9	14.1	13.3	12.6	11.2	10.1	9.1	8.0	150
2	19.9	18.8	17.9	17.0	16.3	15.6	14.3	13.3	12.4	11.6	10.6	9.5	8.5	7.7	6.8	
3	19.6	18.4	17.3	16.4	15.5	14.7	13.4	12.3	11.3	10.5	9.8	8.9	8.0	7.3	6.4	
4	19.4	18.1	16.9	15.8	14.9	14.1	12.7	11.5	10.6	9.8	9.1	8.5	7.7	7.0	6.2	
5	19.3	17.8	16.5	15.4	14.4	13.5	12.1	10.9	10.0	9.2	8.5	7.9	7.4	-	-	
10	18.6	16.7	15.1	13.8	12.7	11.8	10.3	9.1	-	-	-	-	-	-	-	
15	18.1	15.9	14.2	12.8	11.7	10.7	-	-	-	-	-	-	-	-	-	
30	17.2	14.5	12.5	-	-	-	-	-	-	-	-	-	-	-	-	
1	19.9	18.8	17.9	17.0	16.3	15.6	14.3	13.2	11.0	9.4	8.2	7.3	6.6	6.0	5.3	300
2	19.4	18.0	16.9	15.8	14.9	14.1	12.6	10.1	8.4	7.2	6.3	5.6	5.0	4.6	4.0	
3	19.1	17.5	16.1	15.0	14.0	13.1	11.3	9.0	7.5	6.4	5.6	5.0	4.5	4.1	3.6	
4	18.8	17.0	15.6	14.3	13.3	12.4	10.6	8.5	7.1	6.1	5.3	4.7	4.3	3.9	3.4	
5	18.6	16.7	15.1	13.8	12.7	11.8	10.3	8.2	6.8	5.9	5.1	4.6	4.1	-	-	
10	17.8	15.4	13.5	12.1	10.9	10.0	8.5	7.4	-	-	-	-	-	-	-	
15	17.2	14.5	12.5	11.0	9.9	8.9	-	-	-	-	-	-	-	-	-	
30	15.9	12.8	10.7	-	-	-	-	-	-	-	-	-	-	-	-	



**Abaco per carichi in serie - Serial load rating - Abaque de charges successives**

■ 1.5 - 3 ~ - 3000 min<sup>-1</sup>

Potenza ammessa sul tubo in kW, per serie di n esposizioni, con frequenza z e durata di ogni esposizione in sec																
Anode input power as a function of n (N° of exposures in series), z (exp. rate per sec), the exposure time (sec)																
Puissance anodique en fonction de n (N° d'exp. de la série), z (cadence d'exp. par sec), temps d'exposition (sec)																
z	0.010	0.020	0.030	0.040	0.050	0.060	0.080	0.100	0.120	0.140	0.160	0.180	0.200	0.220	0.250	n
1	62.9	62.9	61.2	59.9	59.0	58.2	57.0	56.0	55.1	54.4	53.7	53.1	52.1	51.1	49.7	5
2	62.4	62.4	61.2	59.9	59.0	58.2	56.8	55.2	53.6	52.2	50.8	49.5	48.2	47.1	45.4	
3	61.9	61.9	60.7	59.6	58.4	57.4	55.4	53.5	51.7	50.1	48.5	47.1	45.7	44.4	42.6	
4	61.5	61.5	60.2	58.9	57.6	56.4	54.2	52.1	50.2	48.4	46.8	45.2	43.8	42.4	40.5	
5	61.2	61.2	59.7	58.3	56.9	55.6	53.2	51.0	48.9	47.1	45.3	43.7	42.2	-	-	
10	61.2	60.0	58.0	56.1	54.4	52.8	49.7	47.1	-	-	-	-	-	-	-	
15	61.2	59.1	56.8	54.7	52.7	50.8	-	-	-	-	-	-	-	-	-	
30	60.7	57.4	54.4	-	-	-	-	-	-	-	-	-	-	-	-	
1	62.3	62.3	61.2	59.9	59.0	58.2	56.8	55.2	53.6	52.1	50.8	49.5	48.2	47.0	45.3	10
2	61.5	61.5	60.2	58.8	57.6	56.4	54.1	52.1	50.1	48.3	46.7	45.1	43.7	42.3	40.4	
3	61.2	60.9	59.3	57.7	56.3	54.9	52.3	49.9	47.8	45.8	44.0	42.3	40.7	39.3	37.3	
4	61.2	60.4	58.5	56.8	55.2	53.6	50.8	48.2	45.9	43.8	41.9	40.2	38.6	37.1	35.0	
5	61.2	59.9	57.9	56.0	54.3	52.6	49.6	46.9	44.4	42.3	40.3	38.5	36.8	-	-	
10	61.2	58.3	55.6	53.2	51.0	48.9	45.3	42.2	-	-	-	-	-	-	-	
15	60.6	57.1	54.0	51.3	48.8	46.5	-	-	-	-	-	-	-	-	-	
30	59.1	54.7	50.8	-	-	-	-	-	-	-	-	-	-	-	-	
1	61.5	61.5	60.1	58.8	57.6	56.4	54.1	52.0	50.1	48.3	46.7	45.1	43.6	42.3	40.4	20
2	61.2	60.4	58.5	56.8	55.2	53.6	50.8	48.2	45.9	43.8	41.9	40.1	38.5	37.0	35.0	
3	61.2	59.5	57.3	55.3	53.4	51.7	48.5	45.6	43.1	40.9	38.8	37.0	35.3	33.8	31.7	
4	61.2	58.8	56.4	54.1	52.1	50.1	46.7	43.7	41.0	38.7	36.6	34.7	33.0	31.5	29.4	
5	61.2	58.2	55.6	53.1	50.9	48.9	45.2	42.1	39.3	36.9	34.8	32.9	31.2	-	-	
10	59.9	56.0	52.6	49.6	46.9	44.4	40.3	36.8	-	-	-	-	-	-	-	
15	59.0	54.5	50.5	47.2	44.2	41.6	-	-	-	-	-	-	-	-	-	
30	57.1	51.3	46.5	-	-	-	-	-	-	-	-	-	-	-	-	
1	61.2	60.4	58.5	56.8	55.1	53.6	50.8	48.2	45.9	41.7	36.5	32.5	29.2	26.6	23.4	40
2	61.2	58.8	56.4	54.1	52.0	50.1	46.7	43.6	41.0	38.7	34.6	30.7	27.7	25.2	22.1	
3	60.9	57.7	54.8	52.2	49.9	47.7	43.9	40.7	37.9	35.5	33.3	30.2	27.2	24.7	21.7	
4	60.4	56.8	53.6	50.8	48.2	45.9	41.9	38.5	35.6	33.2	31.0	29.1	26.9	24.5	21.5	
5	59.9	56.0	52.6	49.5	46.8	44.4	40.2	36.8	33.9	31.4	29.2	27.4	25.7	-	-	
10	58.2	53.1	48.9	45.2	42.1	39.3	34.8	31.2	-	-	-	-	-	-	-	
15	57.0	51.1	46.4	42.4	39.0	36.2	-	-	-	-	-	-	-	-	-	
30	54.5	47.2	41.6	-	-	-	-	-	-	-	-	-	-	-	-	
1	61.2	59.5	57.3	55.3	53.4	51.6	48.4	41.0	34.2	29.3	25.6	22.8	20.5	18.6	16.4	60
2	60.9	57.7	54.8	52.2	49.9	47.7	43.9	37.9	31.6	27.1	23.7	21.1	19.0	17.2	15.2	
3	60.1	56.4	53.1	50.1	47.5	45.1	41.0	36.9	30.7	26.4	23.1	20.5	18.4	16.8	14.8	
4	59.5	55.3	51.7	48.4	45.6	43.1	38.8	35.3	30.3	26.0	22.7	20.2	18.2	16.5	14.6	
5	59.0	54.4	50.5	47.1	44.1	41.5	37.1	33.5	30.1	25.8	22.5	20.0	18.0	-	-	
10	57.0	51.1	46.3	42.4	39.0	36.2	31.5	28.0	-	-	-	-	-	-	-	
15	55.6	48.9	43.6	39.3	35.8	32.9	-	-	-	-	-	-	-	-	-	
30	52.6	44.4	38.5	-	-	-	-	-	-	-	-	-	-	-	-	
1	61.2	58.8	56.4	54.1	52.0	50.1	40.4	32.3	26.9	23.1	20.2	17.9	16.2	14.7	12.9	80
2	60.4	56.8	53.6	50.8	48.2	45.9	36.5	29.2	24.3	20.9	18.3	16.2	14.6	13.3	11.7	
3	59.5	55.3	51.7	48.4	45.6	43.1	35.2	28.2	23.5	20.1	17.6	15.7	14.1	12.8	11.3	
4	58.8	54.1	50.1	46.7	43.6	41.0	34.6	27.7	23.1	19.8	17.3	15.4	13.8	12.6	11.1	
5	58.2	53.1	48.8	45.2	42.0	39.3	34.2	27.4	22.8	19.5	17.1	15.2	13.7	-	-	
10	56.0	49.5	44.4	40.2	36.8	33.9	29.2	25.7	-	-	-	-	-	-	-	
15	54.4	47.1	41.5	37.1	33.5	30.6	-	-	-	-	-	-	-	-	-	
30	51.1	42.4	36.2	-	-	-	-	-	-	-	-	-	-	-	-	
1	61.2	58.2	55.6	53.1	50.9	45.1	33.9	27.1	22.6	19.3	16.9	15.0	13.5	12.3	10.8	100
2	59.9	56.0	52.6	49.5	46.8	40.0	30.0	24.0	20.0	17.1	15.0	13.3	12.0	10.9	9.6	
3	59.0	54.4	50.5	47.1	44.1	38.3	28.7	23.0	19.1	16.4	14.4	12.8	11.5	10.4	9.2	
4	58.2	53.1	48.8	45.2	42.0	37.4	28.1	22.4	18.7	16.0	14.0	12.5	11.2	10.2	9.0	
5	57.6	52.0	47.5	43.6	40.4	36.9	27.7	22.1	18.4	15.8	13.8	12.3	11.1	-	-	
10	55.2	48.2	42.8	38.5	35.0	32.1	26.9	21.5	-	-	-	-	-	-	-	
15	53.4	45.6	39.8	35.3	31.7	28.8	-	-	-	-	-	-	-	-	-	
30	49.9	40.7	34.4	-	-	-	-	-	-	-	-	-	-	-	-	
1	60.5	57.0	53.9	50.3	40.2	33.5	25.1	20.1	16.8	14.4	12.6	11.2	10.1	9.1	8.0	150
2	59.0	54.4	50.5	42.6	34.1	28.4	21.3	17.0	14.2	12.2	10.6	9.5	8.5	7.7	6.8	
3	57.9	52.6	48.1	40.0	32.0	26.7	20.0	16.0	13.3	11.4	10.0	8.9	8.0	7.3	6.4	
4	57.0	51.1	46.3	38.7	31.0	25.8	19.3	15.5	12.9	11.1	9.7	8.6	7.7	7.0	6.2	
5	56.2	49.9	44.8	37.9	30.3	25.3	19.0	15.2	12.6	10.8	9.5	8.4	7.6	-	-	
10	53.4	45.6	39.8	35.3	29.1	24.3	18.2	14.6	-	-	-	-	-	-	-	
15	51.4	42.8	36.7	32.1	28.5	23.9	-	-	-	-	-	-	-	-	-	
30	47.5	37.6	31.1	-	-	-	-	-	-	-	-	-	-	-	-	
1	59.0	54.4	43.8	32.9	26.3	21.9	16.4	13.2	11.0	9.4	8.2	7.3	6.6	6.0	5.3	300
2	57.0	50.3	33.5	25.1	20.1	16.8	12.6	10.1	8.4	7.2	6.3	5.6	5.0	4.6	4.0	
3	55.6	45.1	30.1	22.6	18.1	15.0	11.3	9.0	7.5	6.4	5.6	5.0	4.5	4.1	3.6	
4	54.4	42.6	28.4	21.3	17.0	14.2	10.6	8.5	7.1	6.1	5.3	4.7	4.3	3.9	3.4	
5	53.4	41.0	27.3	20.5	16.4	13.7	10.3	8.2	6.8	5.9	5.1	4.6	4.1	-	-	
10	49.9	37.9	25.3	19.0	15.2	12.6	9.5	7.6	-	-	-	-	-	-	-	
15	47.5	36.9	24.6	18.4	14.8	12.3	-	-	-	-	-	-	-	-	-	
30	42.8	32.1	23.9	-	-	-	-	-	-	-	-	-	-	-	-	



**Abaco per carichi in serie - Serial load rating - Abaque de charges successives**

**0.6 - 1 ~ - 10000 min<sup>-1</sup>**

Potenza ammessa sul tubo in kW, per serie di n esposizioni, con frequenza z e durata di ogni esposizione in sec Anode input power as a function of n (N° of exposures in series), z (exp. rate per sec), the exposure time (sec) Puissance admissible en fonction de n (N° d'exp. de la série), z (cadence d'exp. par sec), temps d'exposition (sec)																
z	0.010	0.020	0.030	0.040	0.050	0.060	0.080	0.100	0.120	0.140	0.160	0.180	0.200	0.220	0.250	n
1	33.0	32.1	31.6	31.1	30.8	30.4	29.9	29.4	29.0	28.7	28.4	28.1	27.7	27.2	26.5	5
2	33.0	32.1	31.6	31.1	30.8	30.4	29.9	29.3	28.5	27.8	27.1	26.4	25.7	25.1	24.3	
3	33.0	32.1	31.6	31.1	30.8	30.4	29.4	28.4	27.5	26.7	25.9	25.1	24.4	23.7	22.8	
4	33.0	32.1	31.6	31.1	30.6	30.0	28.8	27.7	26.7	25.8	24.9	24.1	23.4	22.7	21.7	
5	33.0	32.1	31.6	30.9	30.2	29.5	28.3	27.1	26.1	25.1	24.2	23.3	22.5	-	-	
10	32.9	31.8	30.8	29.8	28.9	28.0	26.4	25.0	-	-	-	-	-	-	-	
15	32.6	31.3	30.1	29.0	27.9	27.0	-	-	-	-	-	-	-	-	-	
30	32.1	30.3	28.8	-	-	-	-	-	-	-	-	-	-	-	-	
1	33.0	32.1	31.6	31.1	30.8	30.4	29.9	29.3	28.5	27.8	27.1	26.4	25.7	25.1	24.2	10
2	33.0	32.1	31.6	31.1	30.6	30.0	28.8	27.7	26.7	25.8	24.9	24.1	23.4	22.7	21.7	
3	33.0	32.1	31.4	30.6	29.9	29.2	27.8	26.6	25.5	24.5	23.5	22.6	21.8	21.1	20.0	
4	33.0	32.0	31.1	30.2	29.3	28.5	27.1	25.7	24.5	23.4	22.4	21.5	20.7	19.9	18.8	
5	32.9	31.8	30.7	29.8	28.9	28.0	26.4	25.0	23.8	22.6	21.6	20.6	19.8	-	-	
10	32.4	30.9	29.5	28.3	27.1	26.1	24.2	22.5	-	-	-	-	-	-	-	
15	32.1	30.3	28.7	27.3	26.0	24.8	-	-	-	-	-	-	-	-	-	
30	31.3	29.0	27.0	-	-	-	-	-	-	-	-	-	-	-	-	
1	33.0	32.1	31.6	31.1	30.6	30.0	28.8	27.7	26.7	25.8	24.9	24.1	23.4	22.6	21.7	20
2	33.0	32.0	31.1	30.2	29.3	28.5	27.1	25.7	24.5	23.4	22.4	21.5	20.7	19.9	18.8	
3	32.8	31.6	30.4	29.4	28.4	27.5	25.9	24.4	23.1	21.9	20.8	19.9	19.0	18.2	17.1	
4	32.6	31.2	30.0	28.8	27.7	26.7	24.9	23.4	22.0	20.8	19.7	18.7	17.8	17.0	15.9	
5	32.4	30.9	29.5	28.3	27.1	26.1	24.2	22.5	21.1	19.8	18.7	17.7	16.8	-	-	
10	31.8	29.8	28.0	26.4	25.0	23.8	21.6	19.8	-	-	-	-	-	-	-	
15	31.3	28.9	26.9	25.2	23.6	22.2	-	-	-	-	-	-	-	-	-	
30	30.3	27.3	24.8	-	-	-	-	-	-	-	-	-	-	-	-	
1	33.0	32.0	31.1	30.2	29.3	28.5	27.1	25.7	24.5	23.4	22.4	21.5	20.7	19.9	18.8	40
2	32.6	31.2	30.0	28.8	27.7	26.7	24.9	23.4	22.0	20.8	19.7	18.7	17.8	17.0	15.9	
3	32.3	30.6	29.2	27.8	26.6	25.5	23.5	21.8	20.4	19.1	17.9	16.9	16.0	15.2	14.2	
4	32.0	30.2	28.5	27.1	25.7	24.5	22.4	20.7	19.2	17.9	16.7	15.7	14.8	14.0	13.0	
5	31.8	29.8	28.0	26.4	25.0	23.7	21.6	19.8	18.2	16.9	15.8	14.8	13.9	-	-	
10	30.9	28.3	26.1	24.2	22.5	21.1	18.7	16.8	-	-	-	-	-	-	-	
15	30.3	27.2	24.8	22.7	20.9	19.4	-	-	-	-	-	-	-	-	-	
30	28.9	25.2	22.2	-	-	-	-	-	-	-	-	-	-	-	-	
1	32.8	31.6	30.4	29.4	28.4	27.5	25.9	24.4	23.1	21.9	20.8	19.9	19.0	18.2	16.4	60
2	32.3	30.6	29.2	27.8	26.6	25.5	23.5	21.8	20.4	19.1	17.9	16.9	16.0	15.2	14.2	
3	31.9	30.0	28.2	26.7	25.4	24.1	22.0	20.2	18.7	17.4	16.2	15.2	14.3	13.6	12.5	
4	31.6	29.4	27.5	25.9	24.4	23.1	20.8	19.0	17.4	16.1	15.0	14.0	13.2	12.4	11.4	
5	31.3	28.9	26.9	25.1	23.6	22.2	19.9	18.0	16.5	15.2	14.1	13.1	12.3	-	-	
10	30.3	27.2	24.8	22.7	20.9	19.4	17.0	15.1	-	-	-	-	-	-	-	
15	29.5	26.1	23.3	21.1	19.3	17.7	-	-	-	-	-	-	-	-	-	
30	28.0	23.8	20.6	-	-	-	-	-	-	-	-	-	-	-	-	
1	32.6	31.2	30.0	28.8	27.7	26.7	24.9	23.4	22.0	20.7	19.7	17.9	16.2	14.7	12.9	80
2	32.0	30.2	28.5	27.1	25.7	24.5	22.4	20.7	19.2	17.9	16.7	15.7	14.6	13.3	11.7	
3	31.6	29.4	27.5	25.9	24.4	23.1	20.8	19.0	17.4	16.1	15.0	14.0	13.2	12.4	11.3	
4	31.2	28.8	26.7	24.9	23.4	22.0	19.7	17.8	16.2	14.9	13.8	12.9	12.0	11.3	10.3	
5	30.9	28.3	26.1	24.2	22.5	21.1	18.7	16.8	15.3	14.0	12.9	12.0	11.2	-	-	
10	29.8	26.4	23.7	21.6	19.8	18.2	15.8	13.9	-	-	-	-	-	-	-	
15	28.9	25.1	22.2	19.9	18.0	16.5	-	-	-	-	-	-	-	-	-	
30	27.2	22.7	19.4	-	-	-	-	-	-	-	-	-	-	-	-	
1	32.4	30.9	29.5	28.3	27.1	26.1	24.2	22.5	21.1	19.3	16.9	15.0	13.5	12.3	10.8	100
2	31.8	29.8	28.0	26.4	25.0	23.7	21.6	19.7	18.2	16.9	15.0	13.3	12.0	10.9	9.6	
3	31.3	28.9	26.9	25.1	23.6	22.2	19.9	18.0	16.5	15.2	14.1	12.8	11.5	10.4	9.2	
4	30.9	28.3	26.1	24.2	22.5	21.1	18.7	16.8	15.3	14.0	12.9	12.0	11.2	10.2	9.0	
5	30.6	27.7	25.4	23.4	21.7	20.2	17.8	15.9	14.3	13.1	12.0	11.1	10.3	-	-	
10	29.3	25.7	22.9	20.7	18.8	17.3	14.8	13.0	-	-	-	-	-	-	-	
15	28.4	24.4	21.4	19.0	17.1	15.5	-	-	-	-	-	-	-	-	-	
30	26.6	21.8	18.5	-	-	-	-	-	-	-	-	-	-	-	-	
1	32.1	30.3	28.7	27.2	25.9	24.7	22.7	20.1	16.8	14.4	12.6	11.2	10.1	9.1	8.0	150
2	31.3	28.9	26.9	25.1	23.6	22.2	19.9	17.0	14.2	12.2	10.6	9.5	8.5	7.7	6.8	
3	30.7	28.0	25.7	23.7	22.1	20.6	18.2	16.0	13.3	11.4	10.0	8.9	8.0	7.3	6.4	
4	30.3	27.2	24.7	22.7	20.9	19.4	17.0	15.1	12.9	11.1	9.7	8.6	7.7	7.0	6.2	
5	29.9	26.6	24.0	21.8	20.0	18.5	16.0	14.2	12.6	10.8	9.5	8.4	7.6	-	-	
10	28.4	24.4	21.4	19.0	17.1	15.5	13.2	11.4	-	-	-	-	-	-	-	
15	27.4	22.9	19.7	17.3	15.4	13.9	-	-	-	-	-	-	-	-	-	
30	25.4	20.2	16.8	-	-	-	-	-	-	-	-	-	-	-	-	
1	31.3	28.9	26.9	25.1	23.6	21.9	16.4	13.2	11.0	9.4	8.2	7.3	6.6	6.0	5.3	300
2	30.3	27.2	24.7	22.7	20.1	16.8	12.6	10.1	8.4	7.2	6.3	5.6	5.0	4.6	4.0	
3	29.5	26.1	23.3	21.1	18.1	15.0	11.3	9.0	7.5	6.4	5.6	5.0	4.5	4.1	3.6	
4	28.9	25.1	22.2	19.9	17.0	14.2	10.6	8.5	7.1	6.1	5.3	4.7	4.3	3.9	3.4	
5	28.4	24.4	21.4	19.0	16.4	13.7	10.3	8.2	6.8	5.9	5.1	4.6	4.1	-	-	
10	26.6	21.8	18.5	16.0	14.2	12.6	9.5	7.6	-	-	-	-	-	-	-	
15	25.4	20.2	16.8	14.3	12.5	11.1	-	-	-	-	-	-	-	-	-	
30	22.9	17.3	13.9	-	-	-	-	-	-	-	-	-	-	-	-	



**Abaco per carichi in serie - Serial load rating - Abaque de charges successives**

■ 1.5 - 1 ~ - 10000 min<sup>-1</sup>

Potenza ammessa sul tubo in kW, per serie di n esposizioni, con frequenza z e durata di ogni esposizione in sec																
Anode input power as a function of n (N° of exposures in series), z (exp. rate per sec), the exposure time (sec)																
Puissance anodique en fonction de n (N° d'exp. de la série), z (cadence d'exp. par sec), temps d'exposition (sec)																
z	0.010	0.020	0.030	0.040	0.050	0.060	0.080	0.100	0.120	0.140	0.160	0.180	0.200	0.220	0.250	n
1	102.9	98.7	96.1	94.1	92.5	91.0	88.6	86.7	84.9	83.4	82.1	80.8	79.4	77.4	74.5	5
2	102.9	98.7	96.1	94.1	92.5	91.0	88.6	86.1	82.8	79.6	76.7	74.1	71.5	69.2	66.0	
3	102.9	98.7	96.1	94.1	92.5	91.0	86.5	82.4	78.6	75.2	72.1	69.2	66.5	64.0	60.7	
4	102.9	98.7	96.1	94.1	91.6	88.9	83.9	79.5	75.4	71.8	68.5	65.5	62.8	60.2	56.8	
5	102.9	98.7	96.1	93.1	90.0	87.1	81.8	77.0	72.9	69.1	65.7	62.6	59.8	-	-	
10	102.4	97.1	92.4	88.1	84.2	80.6	74.3	68.9	-	-	-	-	-	-	-	
15	101.2	95.0	89.5	84.6	80.3	76.3	-	-	-	-	-	-	-	-	-	
30	98.6	90.5	83.7	-	-	-	-	-	-	-	-	-	-	-	-	
1	102.9	98.7	96.1	94.1	92.5	91.0	88.6	86.1	82.7	79.6	76.7	74.0	71.5	69.2	65.9	10
2	102.9	98.7	96.1	94.1	91.6	88.9	83.9	79.4	75.4	71.8	68.5	65.5	62.7	60.2	56.8	
3	102.9	98.7	95.5	91.9	88.5	85.4	79.8	74.9	70.6	66.7	63.3	60.1	57.3	54.7	51.3	
4	102.9	98.1	93.8	89.8	86.1	82.8	76.7	71.5	67.0	63.0	59.5	56.3	53.4	50.9	47.4	
5	102.3	97.1	92.3	88.0	84.1	80.5	74.2	68.8	64.1	60.1	56.5	53.3	50.4	-	-	
10	100.1	93.1	87.1	81.8	77.0	72.9	65.7	59.8	-	-	-	-	-	-	-	
15	98.5	90.3	83.4	77.5	72.4	67.9	-	-	-	-	-	-	-	-	-	
30	95.0	84.6	76.3	-	-	-	-	-	-	-	-	-	-	-	-	
1	102.9	98.7	96.1	94.1	91.6	88.9	83.9	79.4	75.4	71.8	68.5	61.5	55.3	50.3	44.3	20
2	102.9	98.1	93.8	89.8	86.1	82.7	76.7	71.5	67.0	63.0	59.4	56.3	53.4	48.9	43.0	
3	101.8	96.1	91.0	86.5	82.3	78.6	72.0	66.5	61.7	57.6	54.0	50.8	48.0	45.4	42.1	
4	100.9	94.5	88.9	83.9	79.4	75.4	68.5	62.7	57.9	53.7	50.1	46.9	44.2	41.7	38.5	
5	100.1	93.1	87.0	81.7	77.0	72.8	65.6	59.8	54.9	50.7	47.1	44.0	41.3	-	-	
10	97.1	88.0	80.5	74.2	68.8	64.1	56.5	50.4	-	-	-	-	-	-	-	
15	94.9	84.5	76.2	69.3	63.6	58.8	-	-	-	-	-	-	-	-	-	
30	90.3	77.5	67.9	-	-	-	-	-	-	-	-	-	-	-	-	
1	102.9	98.1	93.8	89.8	86.1	82.7	73.0	58.4	48.7	41.7	36.5	32.5	29.2	26.6	23.4	40
2	100.9	94.5	88.9	83.9	79.4	75.4	68.5	55.3	46.1	39.5	34.6	30.7	27.7	25.2	22.1	
3	99.4	91.9	85.4	79.8	74.9	70.6	63.3	54.3	45.3	38.8	33.9	30.2	27.2	24.7	21.7	
4	98.1	89.8	82.7	76.7	71.5	67.0	59.4	53.4	44.8	38.4	33.6	29.9	26.9	24.5	21.5	
5	97.1	88.0	80.5	74.2	68.8	64.1	56.4	50.4	44.6	38.2	33.4	29.7	26.7	-	-	
10	93.1	81.7	72.8	65.6	59.8	54.9	47.1	41.3	-	-	-	-	-	-	-	
15	90.3	77.5	67.8	60.3	54.3	49.4	-	-	-	-	-	-	-	-	-	
30	84.5	69.3	58.8	-	-	-	-	-	-	-	-	-	-	-	-	
1	101.8	96.1	91.0	86.5	82.0	68.4	51.3	41.0	34.2	29.3	25.6	22.8	20.5	18.6	16.4	60
2	99.4	91.9	85.4	79.8	74.9	63.2	47.4	37.9	31.6	27.1	23.7	21.1	19.0	17.2	15.2	
3	97.6	88.9	81.6	75.4	70.1	61.5	46.1	36.9	30.7	26.4	23.1	20.5	18.4	16.8	14.8	
4	96.1	86.5	78.6	72.0	66.5	60.6	45.5	36.4	30.3	26.0	22.7	20.2	18.2	16.5	14.6	
5	94.9	84.5	76.1	69.3	63.6	58.7	45.1	36.1	30.1	25.8	22.5	20.0	18.0	-	-	
10	90.3	77.4	67.8	60.3	54.3	49.4	41.8	35.4	-	-	-	-	-	-	-	
15	87.0	72.8	62.6	54.9	48.8	44.0	-	-	-	-	-	-	-	-	-	
30	80.5	64.1	53.3	-	-	-	-	-	-	-	-	-	-	-	-	
1	100.9	94.5	88.9	80.8	64.6	53.8	40.4	32.3	26.9	23.1	20.2	17.9	16.2	14.7	12.9	80
2	98.1	89.8	82.7	73.0	58.4	48.7	36.5	29.2	24.3	20.9	18.3	16.2	14.6	13.3	11.7	
3	96.1	86.5	78.6	70.5	56.4	47.0	35.2	28.2	23.5	20.1	17.6	15.7	14.1	12.8	11.3	
4	94.5	83.9	75.4	68.5	55.3	46.1	34.6	27.7	23.1	19.8	17.3	15.4	13.8	12.6	11.1	
5	93.1	81.7	72.8	65.6	54.7	45.6	34.2	27.4	22.8	19.5	17.1	15.2	13.7	-	-	
10	88.0	74.2	64.1	56.4	50.4	44.6	33.4	26.7	-	-	-	-	-	-	-	
15	84.5	69.3	58.7	51.0	45.0	40.3	-	-	-	-	-	-	-	-	-	
30	77.5	60.3	49.4	-	-	-	-	-	-	-	-	-	-	-	-	
1	100.1	93.1	87.0	67.7	54.2	45.1	33.9	27.1	22.6	19.3	16.9	15.0	13.5	12.3	10.8	100
2	97.1	88.0	80.0	60.0	48.0	40.0	30.0	24.0	20.0	17.1	15.0	13.3	12.0	10.9	9.6	
3	94.9	84.5	76.1	57.4	45.9	38.3	28.7	23.0	19.1	16.4	14.4	12.8	11.5	10.4	9.2	
4	93.1	81.7	72.8	56.1	44.9	37.4	28.1	22.4	18.7	16.0	14.0	12.5	11.2	10.2	9.0	
5	91.6	79.4	70.1	55.3	44.3	36.9	27.7	22.1	18.4	15.8	13.8	12.3	11.1	-	-	
10	86.1	71.5	61.2	53.4	43.0	35.9	26.9	21.5	-	-	-	-	-	-	-	
15	82.3	66.5	55.7	48.0	42.1	35.5	-	-	-	-	-	-	-	-	-	
30	74.9	57.3	46.4	-	-	-	-	-	-	-	-	-	-	-	-	
1	98.4	90.3	67.1	50.3	40.2	33.5	25.1	20.1	16.8	14.4	12.6	11.2	10.1	9.1	8.0	150
2	94.9	84.5	56.8	42.6	34.1	28.4	21.3	17.0	14.2	12.2	10.6	9.5	8.5	7.7	6.8	
3	92.3	80.0	53.3	40.0	32.0	26.7	20.0	16.0	13.3	11.4	10.0	8.9	8.0	7.3	6.4	
4	90.3	77.4	51.6	38.7	31.0	25.8	19.3	15.5	12.9	11.1	9.7	8.6	7.7	7.0	6.2	
5	88.5	74.9	50.6	37.9	30.3	25.3	19.0	15.2	12.6	10.8	9.5	8.4	7.6	-	-	
10	82.3	66.5	48.5	36.4	29.1	24.3	18.2	14.6	-	-	-	-	-	-	-	
15	78.1	61.2	47.8	35.9	28.7	23.9	-	-	-	-	-	-	-	-	-	
30	70.1	51.8	41.1	-	-	-	-	-	-	-	-	-	-	-	-	
1	94.9	65.8	43.8	32.9	26.3	21.9	16.4	13.2	11.0	9.4	8.2	7.3	6.6	6.0	5.3	300
2	90.3	50.3	33.5	25.1	20.1	16.8	12.6	10.1	8.4	7.2	6.3	5.6	5.0	4.6	4.0	
3	87.0	45.1	30.1	22.6	18.1	15.0	11.3	9.0	7.5	6.4	5.6	5.0	4.5	4.1	3.6	
4	84.5	42.6	28.4	21.3	17.0	14.2	10.6	8.5	7.1	6.1	5.3	4.7	4.3	3.9	3.4	
5	82.0	41.0	27.3	20.5	16.4	13.7	10.3	8.2	6.8	5.9	5.1	4.6	4.1	-	-	
10	74.9	37.9	25.3	19.0	15.2	12.6	9.5	7.6	-	-	-	-	-	-	-	
15	70.1	36.9	24.6	18.4	14.8	12.3	-	-	-	-	-	-	-	-	-	
30	61.2	35.9	23.9	-	-	-	-	-	-	-	-	-	-	-	-	



**Abaco per carichi in serie - Serial load rating - Abaque de charges successives**

▣ **0.6 - 3 ~ - 10000 min<sup>-1</sup>**

Potenza ammessa sul tubo in kW, per serie di n esposizioni, con frequenza z e durata di ogni esposizione in sec Anode input power as a function of n (N° of exposures in series), z (exp. rate per sec), the exposure time (sec) Puissance anodique en fonction de n (N° d'exp. de la série), z (cadence d'exp. par sec), temps d'exposition (sec)																	
z	0.010	0.020	0.030	0.040	0.050	0.060	0.080	0.100	0.120	0.140	0.160	0.180	0.200	0.220	0.250	n	
1	39.4	38.1	37.3	36.7	36.2	35.8	35.0	34.4	33.9	33.4	32.9	32.5	32.1	31.4	30.4	5	
2	39.4	38.1	37.3	36.7	36.2	35.8	35.0	34.2	33.2	32.1	31.2	30.3	29.4	28.6	27.5		
3	39.4	38.1	37.3	36.7	36.2	35.8	34.4	33.0	31.8	30.7	29.6	28.6	27.7	26.8	25.6		
4	39.4	38.1	37.3	36.7	36.0	35.1	33.5	32.1	30.8	29.5	28.4	27.4	26.4	25.5	24.2		
5	39.4	38.1	37.3	36.4	35.5	34.5	32.8	31.3	29.9	28.6	27.4	26.3	25.3	-	-		
10	39.2	37.6	36.2	34.9	33.6	32.5	30.4	28.5	-	-	-	-	-	-	-		
15	38.8	37.0	35.3	33.8	32.3	31.1	-	-	-	-	-	-	-	-	-		
30	38.1	35.6	33.5	-	-	-	-	-	-	-	-	-	-	-	-		
1	39.4	38.1	37.3	36.7	36.2	35.8	35.0	34.2	33.2	32.1	31.2	30.3	29.4	28.6	27.5	10	
2	39.4	38.1	37.3	36.7	35.9	35.1	33.5	32.1	30.7	29.5	28.4	27.3	26.4	25.5	24.2		
3	39.4	38.1	37.1	36.0	35.0	34.0	32.2	30.6	29.1	27.8	26.6	25.5	24.4	23.5	22.2		
4	39.4	37.9	36.6	35.4	34.2	33.2	31.2	29.4	27.9	26.5	25.2	24.1	23.0	22.0	20.7		
5	39.2	37.6	36.2	34.8	33.6	32.4	30.3	28.5	26.9	25.4	24.1	22.9	21.9	-	-		
10	38.5	36.4	34.5	32.8	31.3	29.9	27.4	25.3	-	-	-	-	-	-	-		
15	38.0	35.6	33.4	31.5	29.7	28.2	-	-	-	-	-	-	-	-	-		
30	37.0	33.8	31.1	-	-	-	-	-	-	-	-	-	-	-	-		
1	39.4	38.1	37.3	36.7	35.9	35.1	33.5	32.1	30.7	29.5	28.4	27.3	26.4	25.5	24.2	20	
2	39.4	37.9	36.6	35.4	34.2	33.2	31.2	29.4	27.9	26.5	25.2	24.0	23.0	22.0	20.7		
3	39.0	37.3	35.8	34.3	33.0	31.8	29.6	27.7	26.0	24.5	23.2	22.0	20.9	20.0	18.7		
4	38.8	36.8	35.1	33.5	32.1	30.7	28.4	26.4	24.6	23.1	21.7	20.5	19.5	18.5	17.2		
5	38.5	36.4	34.5	32.8	31.3	29.9	27.4	25.3	23.5	22.0	20.6	19.4	18.3	-	-		
10	37.6	34.8	32.4	30.3	28.5	26.9	24.1	21.9	-	-	-	-	-	-	-		
15	37.0	33.7	31.0	28.7	26.7	25.0	-	-	-	-	-	-	-	-	-		
30	35.6	31.5	28.2	-	-	-	-	-	-	-	-	-	-	-	-		
1	39.4	37.9	36.6	35.4	34.2	33.1	31.2	29.4	27.9	26.5	25.2	24.0	23.0	22.0	20.7	40	
2	38.8	36.8	35.1	33.5	32.1	30.7	28.4	26.4	24.6	23.1	21.7	20.5	19.5	18.5	17.2		
3	38.3	36.0	34.0	32.2	30.6	29.1	26.6	24.4	22.6	21.0	19.7	18.5	17.4	16.5	15.2		
4	37.9	35.4	33.2	31.2	29.4	27.9	25.2	23.0	21.1	19.6	18.2	17.0	16.0	15.1	13.9		
5	37.6	34.8	32.4	30.3	28.5	26.9	24.1	21.9	20.0	18.4	17.1	15.9	14.9	-	-		
10	36.4	32.8	29.9	27.4	25.3	23.5	20.6	18.3	-	-	-	-	-	-	-		
15	35.5	31.4	28.2	25.5	23.3	21.5	-	-	-	-	-	-	-	-	-		
30	33.7	28.7	25.0	-	-	-	-	-	-	-	-	-	-	-	-		
1	39.0	37.3	35.8	34.3	33.0	31.8	29.6	27.7	26.0	24.5	23.2	22.0	20.5	18.6	16.4	60	
2	38.3	36.0	34.0	32.2	30.6	29.1	26.6	24.4	22.6	21.0	19.7	18.5	17.4	16.5	15.2		
3	37.8	35.1	32.8	30.7	28.9	27.3	24.6	22.4	20.5	19.0	17.6	16.4	15.4	14.5	13.3		
4	37.3	34.3	31.8	29.6	27.7	26.0	23.2	20.9	19.1	17.5	16.2	15.1	14.1	13.2	12.1		
5	37.0	33.7	31.0	28.7	26.7	24.9	22.1	19.8	17.9	16.4	15.1	14.0	13.1	-	-		
10	35.5	31.4	28.2	25.5	23.3	21.5	18.5	16.3	-	-	-	-	-	-	-		
15	34.5	29.9	26.3	23.5	21.3	19.4	-	-	-	-	-	-	-	-	-		
30	32.4	26.9	22.9	-	-	-	-	-	-	-	-	-	-	-	-		
1	38.8	36.8	35.1	33.5	32.1	30.7	28.4	26.4	24.6	23.1	21.7	20.2	17.9	16.2	14.7	12.9	80
2	37.9	35.4	33.1	31.2	29.4	27.9	25.2	23.0	21.1	19.6	18.2	16.2	14.6	13.3	11.7		
3	37.3	34.3	31.8	29.6	27.7	26.0	23.2	20.9	19.1	17.5	16.2	15.1	14.1	12.8	11.3		
4	36.8	33.5	30.7	28.4	26.4	24.6	21.7	19.5	17.6	16.1	14.8	13.7	12.8	11.9	10.9		
5	36.4	32.8	29.9	27.4	25.3	23.5	20.6	18.3	16.5	15.0	13.8	12.7	11.8	-	-		
10	34.8	30.3	26.9	24.1	21.9	20.0	17.1	14.9	-	-	-	-	-	-	-		
15	33.7	28.7	24.9	22.1	19.8	17.9	-	-	-	-	-	-	-	-	-		
30	31.4	25.5	21.5	-	-	-	-	-	-	-	-	-	-	-	-		
1	38.5	36.4	34.5	32.8	31.3	29.9	27.4	25.3	22.6	19.3	16.9	15.0	13.5	12.3	10.8	100	
2	37.6	34.8	32.4	30.3	28.5	26.9	24.1	21.9	20.0	17.1	15.0	13.3	12.0	10.9	9.6		
3	37.0	33.7	31.0	28.7	26.7	24.9	22.1	19.8	17.9	16.4	14.4	12.8	11.5	10.4	9.2		
4	36.4	32.8	29.9	27.4	25.3	23.5	20.6	18.3	16.5	15.0	13.8	12.5	11.2	10.2	9.0		
5	35.9	32.1	28.9	26.4	24.2	22.4	19.5	17.2	15.4	14.0	12.8	11.8	10.9	-	-		
10	34.2	29.4	25.8	23.0	20.7	18.9	16.0	13.9	-	-	-	-	-	-	-		
15	33.0	27.7	23.8	20.9	18.7	16.8	-	-	-	-	-	-	-	-	-		
30	30.6	24.4	20.3	-	-	-	-	-	-	-	-	-	-	-	-		
1	38.0	35.5	33.3	31.4	29.7	28.2	25.1	20.1	16.8	14.4	12.6	11.2	10.1	9.1	8.0	150	
2	37.0	33.7	31.0	28.7	26.7	24.9	21.3	17.0	14.2	12.2	10.6	9.5	8.5	7.7	6.8		
3	36.2	32.4	29.4	26.9	24.7	22.9	20.0	16.0	13.3	11.4	10.0	8.9	8.0	7.3	6.4		
4	35.5	31.4	28.2	25.5	23.3	21.5	18.5	15.5	12.9	11.1	9.7	8.6	7.7	7.0	6.2		
5	35.0	30.6	27.2	24.4	22.2	20.3	17.4	15.2	12.6	10.8	9.5	8.4	7.6	-	-		
10	33.0	27.7	23.8	20.9	18.7	16.8	14.1	12.1	-	-	-	-	-	-	-		
15	31.7	25.8	21.8	18.9	16.6	14.9	-	-	-	-	-	-	-	-	-		
30	28.9	22.4	18.3	-	-	-	-	-	-	-	-	-	-	-	-		
1	37.0	33.7	31.0	28.7	26.3	21.9	16.4	13.2	11.0	9.4	8.2	7.3	6.6	6.0	5.3	300	
2	35.5	31.4	28.2	25.1	20.1	16.8	12.6	10.1	8.4	7.2	6.3	5.6	5.0	4.6	4.0		
3	34.5	29.9	26.3	22.6	18.1	15.0	11.3	9.0	7.5	6.4	5.6	5.0	4.5	4.1	3.6		
4	33.7	28.7	24.9	21.3	17.0	14.2	10.6	8.5	7.1	6.1	5.3	4.7	4.3	3.9	3.4		
5	33.0	27.7	23.8	20.5	16.4	13.7	10.3	8.2	6.8	5.9	5.1	4.6	4.1	-	-		
10	30.6	24.4	20.3	17.4	15.2	12.6	9.5	7.6	-	-	-	-	-	-	-		
15	28.9	22.4	18.3	15.4	13.3	11.8	-	-	-	-	-	-	-	-	-		
30	25.8	18.9	14.9	-	-	-	-	-	-	-	-	-	-	-	-		



**Abaco per carichi in serie - Serial load rating - Abaque de charges successives**

**■ 1.5 - 3 ~ - 10000 min<sup>-1</sup>**

Potenza ammessa sul tubo in kW, per serie di n esposizioni, con frequenza z e durata di ogni esposizione in sec																
Anode input power as a function of n (N° of exposures in series), z (exp. rate per sec), the exposure time (sec)																
Puissance anodique en fonction de n (N° d'exp. de la série), z (cadence d'exp. par sec), temps d'exposition (sec)																
z	0.010	0.020	0.030	0.040	0.050	0.060	0.080	0.100	0.120	0.140	0.160	0.180	0.200	0.220	0.250	n
1	122.3	116.4	112.8	110.1	107.8	105.9	102.7	100.0	97.7	95.7	94.0	92.3	90.5	87.8	84.1	5
2	122.3	116.4	112.8	110.1	107.8	105.9	102.7	99.3	94.9	90.8	87.0	83.6	80.4	77.5	73.4	
3	122.3	116.4	112.8	110.1	107.8	105.9	99.8	94.3	89.5	85.0	81.0	77.4	74.1	71.0	66.9	
4	122.3	116.4	112.8	110.1	106.7	103.0	96.4	90.5	85.4	80.8	76.6	72.9	69.5	66.4	62.3	
5	122.3	116.4	112.8	108.7	104.5	100.6	93.5	87.4	82.1	77.3	73.1	69.3	65.9	-	-	
10	121.5	114.2	107.7	101.9	96.7	92.1	83.9	77.1	-	-	-	-	-	-	-	
15	119.8	111.3	103.8	97.3	91.6	86.5	-	-	-	-	-	-	-	-	-	
30	116.2	105.2	96.1	-	-	-	-	-	-	-	-	-	-	-	-	
1	122.3	116.4	112.8	110.1	107.8	105.9	102.7	99.3	94.8	90.7	87.0	83.6	80.4	77.4	73.4	10
2	122.3	116.4	112.8	110.1	106.6	103.0	96.3	90.5	85.3	80.7	76.6	72.8	69.4	66.3	62.2	
3	122.3	116.4	112.0	107.0	102.5	98.4	91.0	84.7	79.2	74.4	70.1	66.3	62.9	59.8	55.7	
4	122.3	115.6	109.6	104.2	99.3	94.9	87.0	80.4	74.7	69.8	65.5	61.6	58.2	55.2	51.2	
5	121.5	114.2	107.6	101.8	96.6	91.9	83.8	77.0	71.2	66.2	61.8	58.0	54.7	-	-	
10	118.4	108.7	100.6	93.5	87.4	82.1	73.1	65.9	-	-	-	-	-	-	-	
15	116.1	104.9	95.8	88.0	81.5	75.8	-	-	-	-	-	-	-	-	-	
30	111.3	97.3	86.5	-	-	-	-	-	-	-	-	-	-	-	-	
1	122.3	116.4	112.8	110.1	106.6	103.0	96.3	90.5	85.3	79.1	69.2	61.5	55.3	50.3	44.3	20
2	122.3	115.6	109.6	104.2	99.3	94.8	87.0	80.4	74.7	69.7	65.4	59.8	53.8	48.9	43.0	
3	120.7	112.8	105.9	99.8	94.3	89.4	81.0	74.0	68.2	63.2	58.9	55.1	51.8	48.4	42.6	
4	119.4	110.6	103.0	96.3	90.5	85.3	76.6	69.4	63.5	58.5	54.3	50.6	47.4	44.6	40.9	
5	118.3	108.7	100.5	93.5	87.4	82.0	73.0	65.8	59.9	55.0	50.8	47.2	44.1	-	-	
10	114.2	101.8	91.9	83.8	77.0	71.2	61.8	54.7	-	-	-	-	-	-	-	
15	111.1	97.2	86.3	77.6	70.5	64.6	-	-	-	-	-	-	-	-	-	
30	104.9	88.0	75.8	-	-	-	-	-	-	-	-	-	-	-	-	
1	122.3	115.6	109.6	104.2	99.3	94.8	73.0	58.4	48.7	41.7	36.5	32.5	29.2	26.6	23.4	40
2	119.4	110.6	103.0	96.3	90.5	85.3	69.2	55.3	46.1	39.5	34.6	30.7	27.7	25.2	22.1	
3	117.3	107.0	98.4	91.0	84.7	79.2	67.9	54.3	45.3	38.8	33.9	30.2	27.2	24.7	21.7	
4	115.6	104.2	94.8	87.0	80.4	74.7	65.4	53.8	44.8	38.4	33.6	29.9	26.9	24.5	21.5	
5	114.1	101.8	91.9	83.7	76.9	71.1	61.8	53.5	44.6	38.2	33.4	29.7	26.7	-	-	
10	108.7	93.5	82.0	73.0	65.8	59.9	50.8	44.1	-	-	-	-	-	-	-	
15	104.9	88.0	75.7	66.5	59.3	53.5	-	-	-	-	-	-	-	-	-	
30	97.2	77.6	64.6	-	-	-	-	-	-	-	-	-	-	-	-	
1	120.7	112.8	105.9	99.8	82.0	68.4	51.3	41.0	34.2	29.3	25.6	22.8	20.5	18.6	16.4	60
2	117.3	107.0	98.4	91.0	75.8	63.2	47.4	37.9	31.6	27.1	23.7	21.1	19.0	17.2	15.2	
3	114.8	103.0	93.3	85.3	73.8	61.5	46.1	36.9	30.7	26.4	23.1	20.5	18.4	16.8	14.8	
4	112.8	99.8	89.4	81.0	72.8	60.6	45.5	36.4	30.3	26.0	22.7	20.2	18.2	16.5	14.6	
5	111.1	97.1	86.2	77.6	70.5	60.1	45.1	36.1	30.1	25.8	22.5	20.0	18.0	-	-	
10	104.9	87.9	75.7	66.5	59.2	53.4	44.3	35.4	-	-	-	-	-	-	-	
15	100.5	82.0	69.2	59.9	52.8	47.2	-	-	-	-	-	-	-	-	-	
30	91.9	71.2	58.0	-	-	-	-	-	-	-	-	-	-	-	-	
1	119.4	110.6	103.0	80.8	64.6	53.8	40.4	32.3	26.9	23.1	20.2	17.9	16.2	14.7	12.9	80
2	115.6	104.2	94.8	73.0	58.4	48.7	36.5	29.2	24.3	20.9	18.3	16.2	14.6	13.3	11.7	
3	112.8	99.8	89.4	70.5	56.4	47.0	35.2	28.2	23.5	20.1	17.6	15.7	14.1	12.8	11.3	
4	110.6	96.3	85.3	69.2	55.3	46.1	34.6	27.7	23.1	19.8	17.3	15.4	13.8	12.6	11.1	
5	108.7	93.5	82.0	68.4	54.7	45.6	34.2	27.4	22.8	19.5	17.1	15.2	13.7	-	-	
10	101.8	83.7	71.1	61.8	53.5	44.6	33.4	26.7	-	-	-	-	-	-	-	
15	97.1	77.6	64.6	55.3	48.4	43.0	-	-	-	-	-	-	-	-	-	
30	88.0	66.5	53.5	-	-	-	-	-	-	-	-	-	-	-	-	
1	118.3	108.7	90.3	67.7	54.2	45.1	33.9	27.1	22.6	19.3	16.9	15.0	13.5	12.3	10.8	100
2	114.1	101.8	80.0	60.0	48.0	40.0	30.0	24.0	20.0	17.1	15.0	13.3	12.0	10.9	9.6	
3	111.1	97.1	76.5	57.4	45.9	38.3	28.7	23.0	19.1	16.4	14.4	12.8	11.5	10.4	9.2	
4	108.7	93.5	74.8	56.1	44.9	37.4	28.1	22.4	18.7	16.0	14.0	12.5	11.2	10.2	9.0	
5	106.6	90.5	73.8	55.3	44.3	36.9	27.7	22.1	18.4	15.8	13.8	12.3	11.1	-	-	
10	99.3	80.4	67.5	53.8	43.0	35.9	26.9	21.5	-	-	-	-	-	-	-	
15	94.3	74.0	60.9	51.8	42.6	35.5	-	-	-	-	-	-	-	-	-	
30	84.7	62.9	50.0	-	-	-	-	-	-	-	-	-	-	-	-	
1	116.0	100.6	67.1	50.3	40.2	33.5	25.1	20.1	16.8	14.4	12.6	11.2	10.1	9.1	8.0	150
2	111.1	85.1	56.8	42.6	34.1	28.4	21.3	17.0	14.2	12.2	10.6	9.5	8.5	7.7	6.8	
3	107.6	80.0	53.3	40.0	32.0	26.7	20.0	16.0	13.3	11.4	10.0	8.9	8.0	7.3	6.4	
4	104.8	77.4	51.6	38.7	31.0	25.8	19.3	15.5	12.9	11.1	9.7	8.6	7.7	7.0	6.2	
5	102.5	75.8	50.6	37.9	30.3	25.3	19.0	15.2	12.6	10.8	9.5	8.4	7.6	-	-	
10	94.3	72.8	48.5	36.4	29.1	24.3	18.2	14.6	-	-	-	-	-	-	-	
15	88.8	67.5	47.8	35.9	28.7	23.9	-	-	-	-	-	-	-	-	-	
30	78.6	56.3	43.9	-	-	-	-	-	-	-	-	-	-	-	-	
1	111.1	65.8	43.8	32.9	26.3	21.9	16.4	13.2	11.0	9.4	8.2	7.3	6.6	6.0	5.3	300
2	100.6	50.3	33.5	25.1	20.1	16.8	12.6	10.1	8.4	7.2	6.3	5.6	5.0	4.6	4.0	
3	90.3	45.1	30.1	22.6	18.1	15.0	11.3	9.0	7.5	6.4	5.6	5.0	4.5	4.1	3.6	
4	85.1	42.6	28.4	21.3	17.0	14.2	10.6	8.5	7.1	6.1	5.3	4.7	4.3	3.9	3.4	
5	82.0	41.0	27.3	20.5	16.4	13.7	10.3	8.2	6.8	5.9	5.1	4.6	4.1	-	-	
10	75.8	37.9	25.3	19.0	15.2	12.6	9.5	7.6	-	-	-	-	-	-	-	
15	73.8	36.9	24.6	18.4	14.8	12.3	-	-	-	-	-	-	-	-	-	
30	67.5	35.9	23.9	-	-	-	-	-	-	-	-	-	-	-	-	



**Caratteristica di emissione del catodo**  
**Cathode emission characteristic**  
**Caractéristique d'émission de la cathode**  
 ☐ 0.6 - 3 ~ - (± 0.2 A)

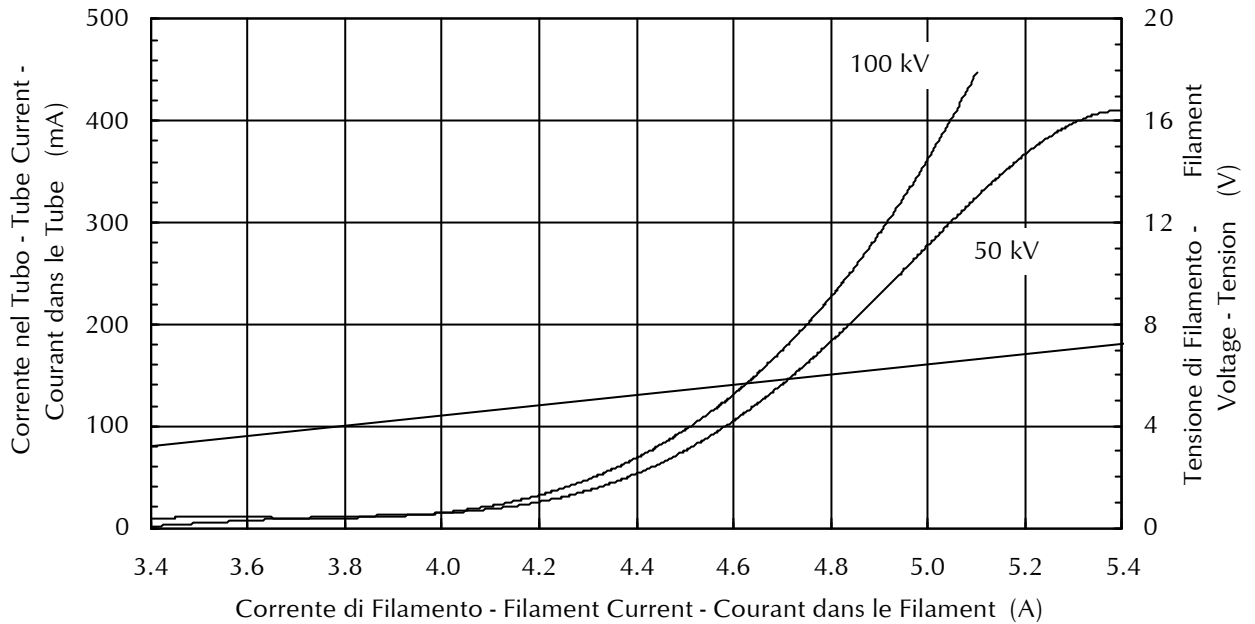

**Caratteristica di emissione del catodo**  
**Cathode emission characteristic**  
**Caractéristique d'émission de la cathode**  
 ■ 1.5 - 3 ~ - (± 0.2 A)

